

980428

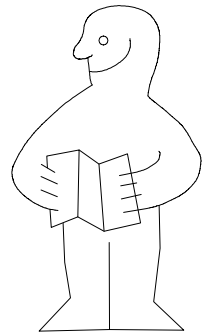

1-2-3-4... ○

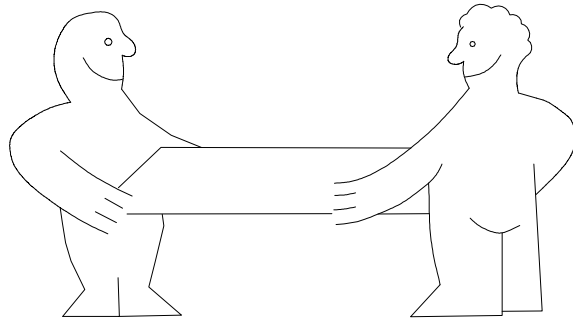
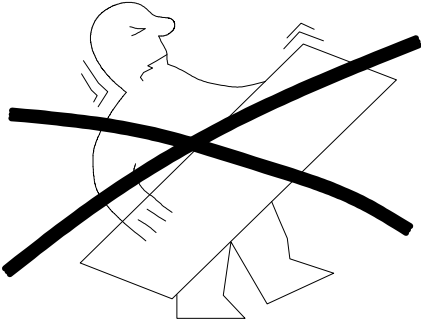
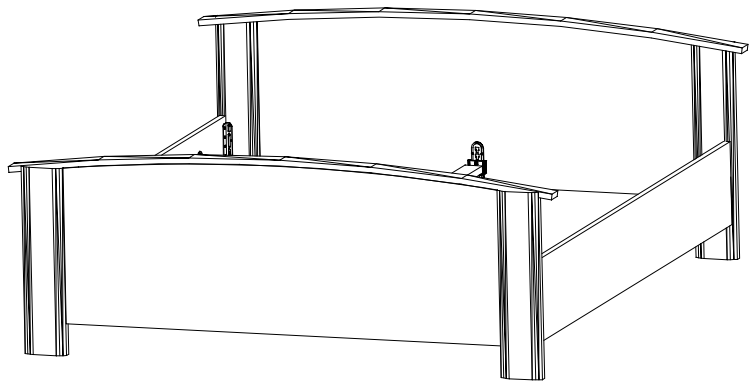
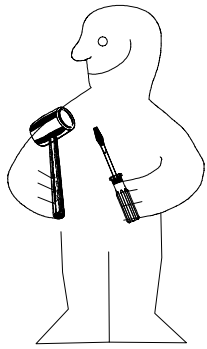
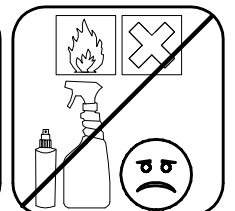
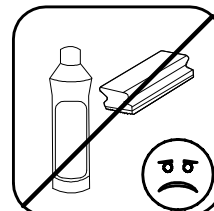
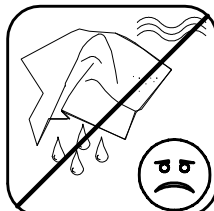
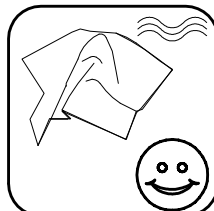
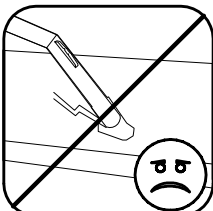
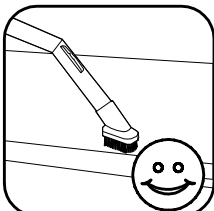
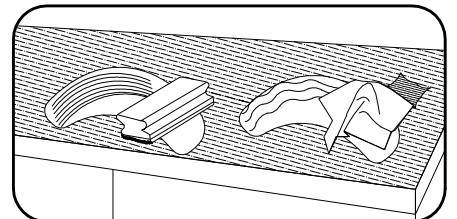
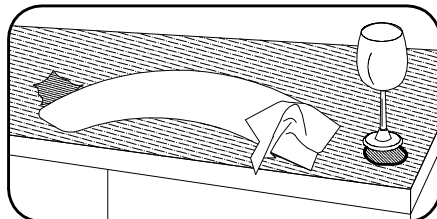
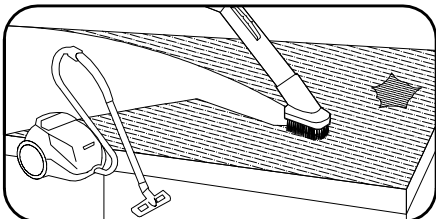
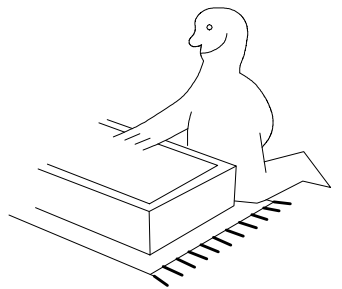
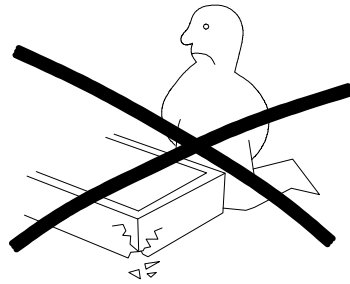
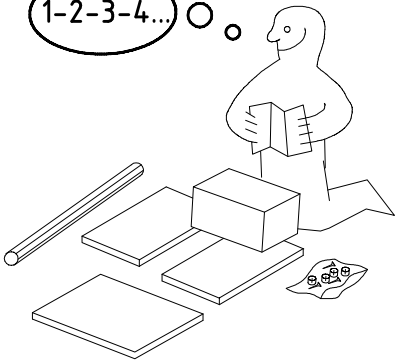

980428

06.08.10 / 29.09.11

09 11

1/4

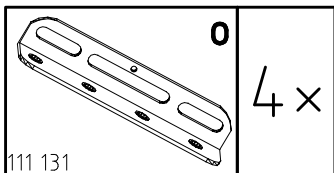

0

4 x

111 131

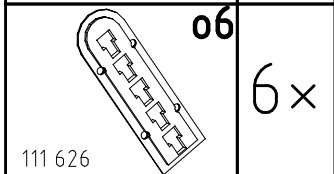

06

6 x

111 626

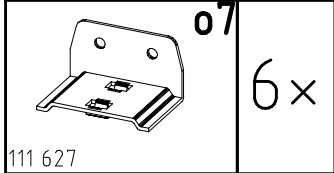

07

6 x

111 627

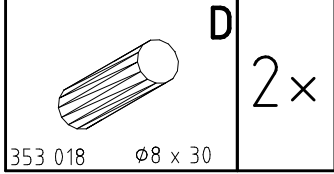

D

2 x

353 018

∅8 x 30

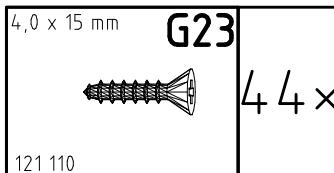

4,0 x 15 mm

G23

4 4 x

121 110

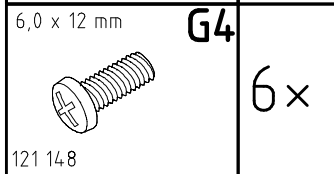

6,0 x 12 mm

G4

6 x

121 148

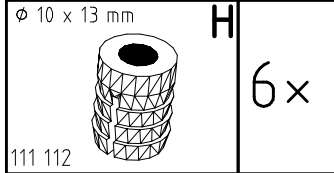

∅ 10 x 13 mm

H

6 x

111 112

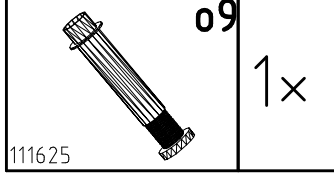

09

1 x

111625

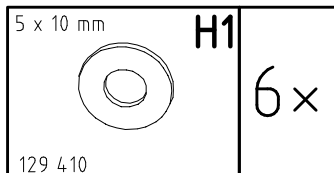

5 x 10 mm

H1

6 x

129 410

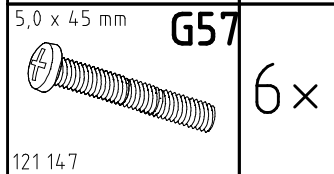

5,0 x 45 mm

G57

6 x

121 147

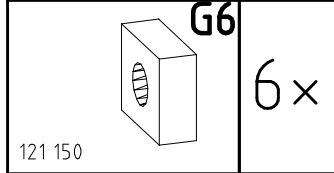

G6

6 x

121 150

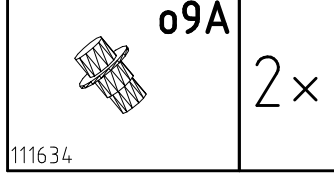

09A

2 x

111634

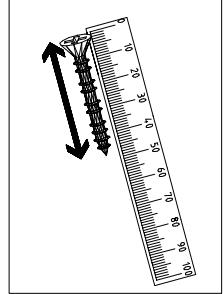
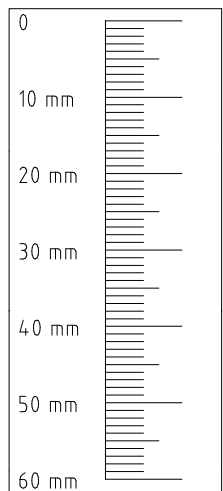

2x (1) 2000x290x22

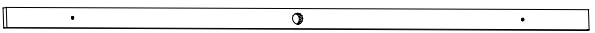

1x (6) 1980x63x25

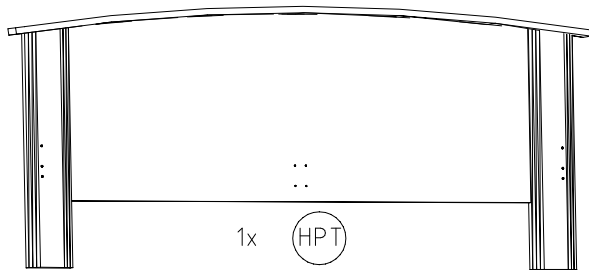

1x (HPT)

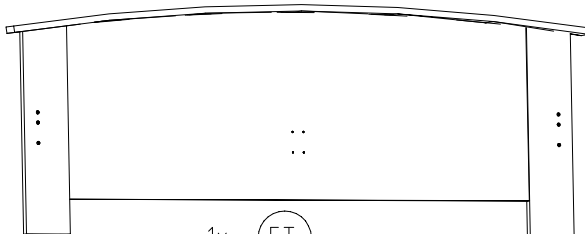

1x (FT)

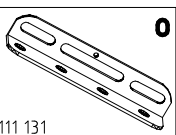
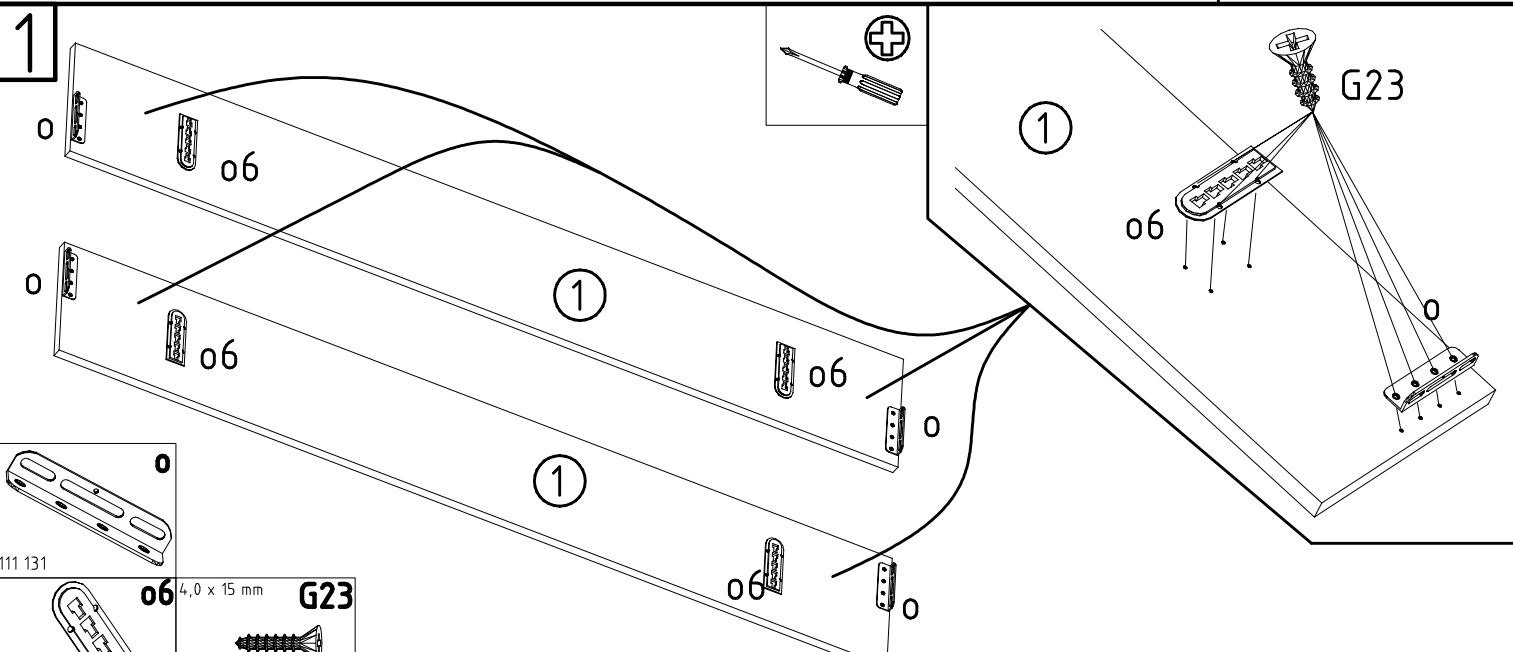
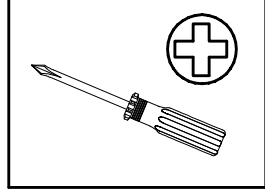
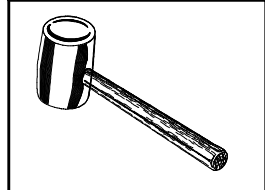
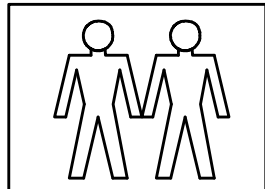

111 131

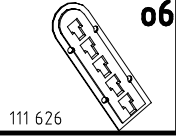

111 626

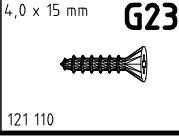

121 110

980428

06.08.10 / 29.09.11

09 11

2 / 4

2

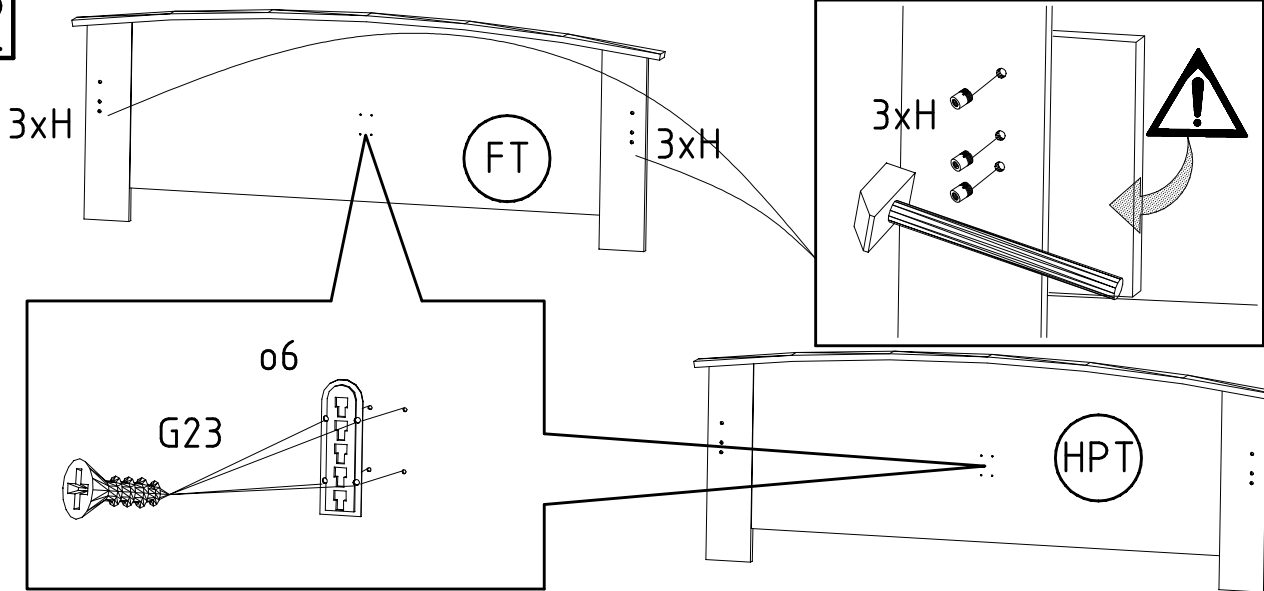

- Ø 10 x 13 mm H
- 111 112
- 4,0 x 15 mm G23
- 121 110
- 111 626

3

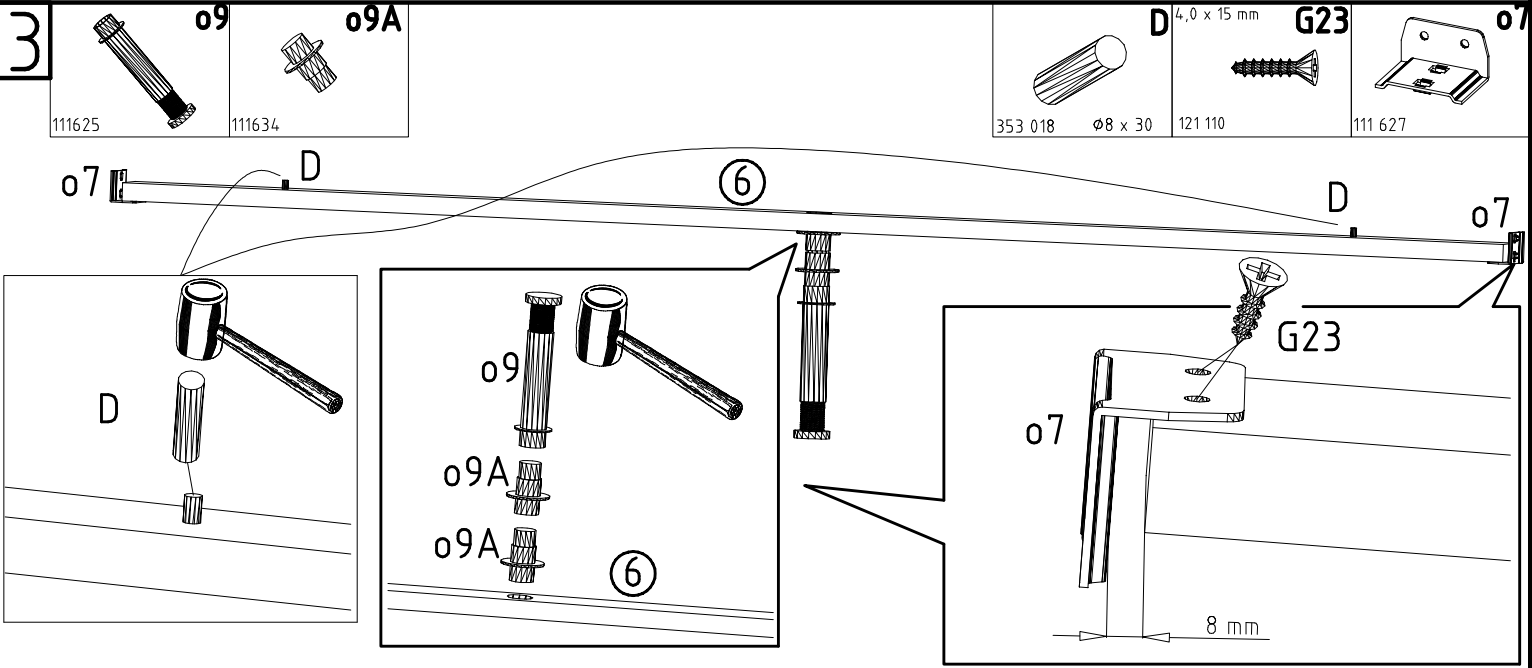

- 111625 o9
- 111634 o9A
- 353 018 D
- Ø8 x 30
- 121 110 G23
- 111 627 o7

4

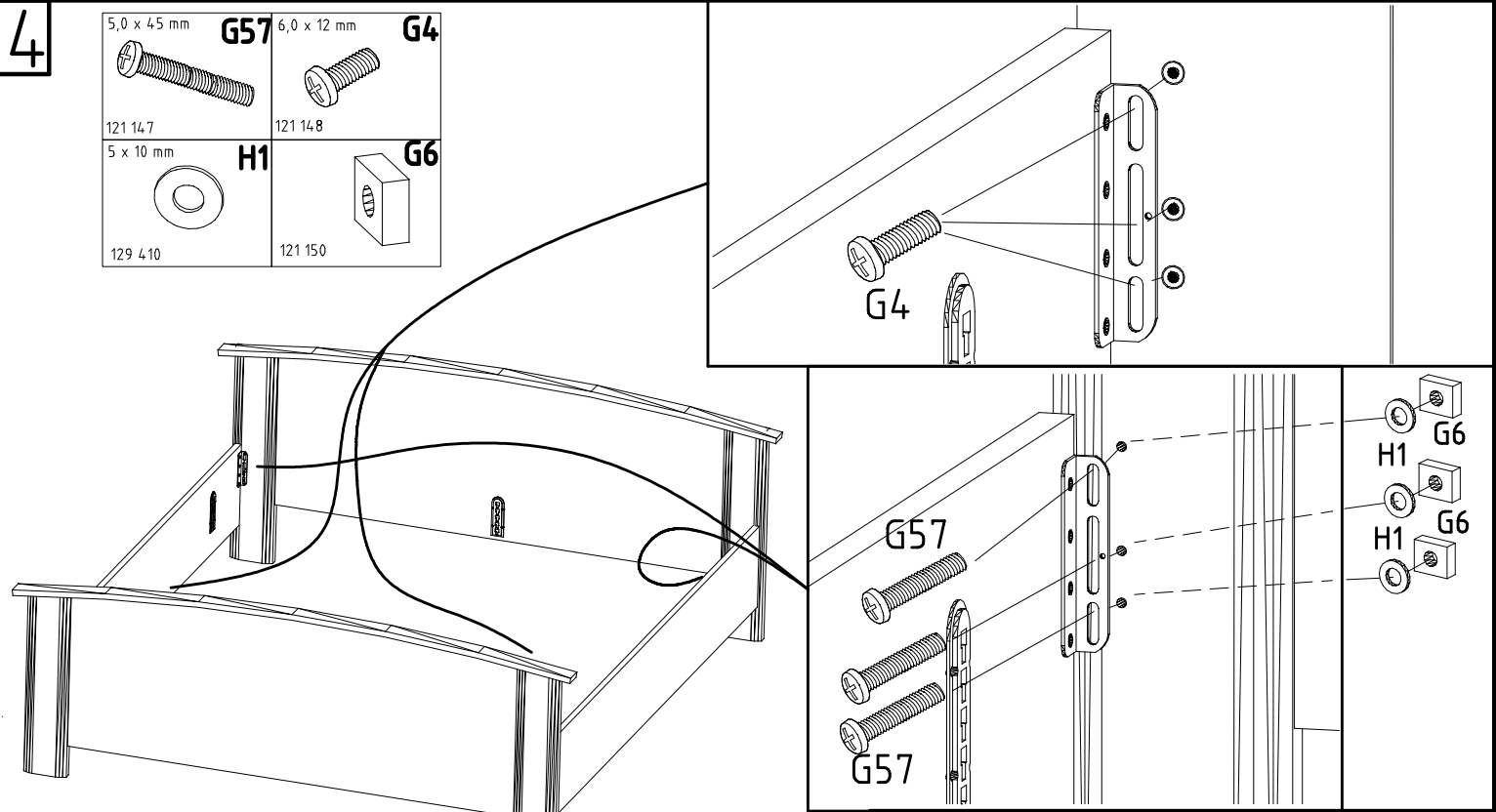

- 5,0 x 45 mm G57
- 6,0 x 12 mm G4
- 121 147
- 121 148
- 5 x 10 mm H1
- 129 410
- 121 150 G6

- G6
- H1
- G6

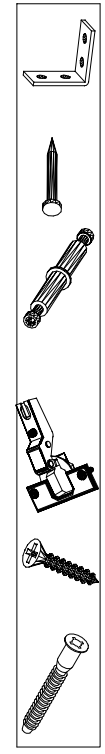
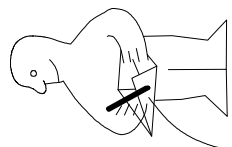
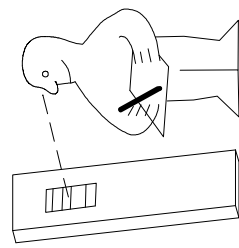
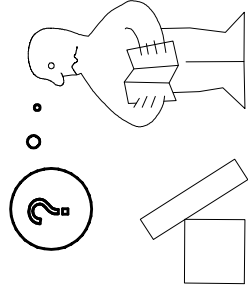
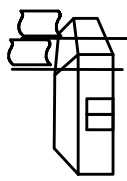
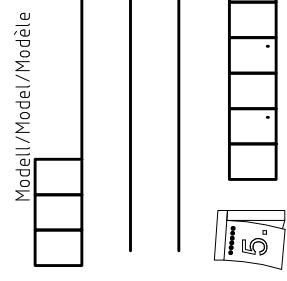
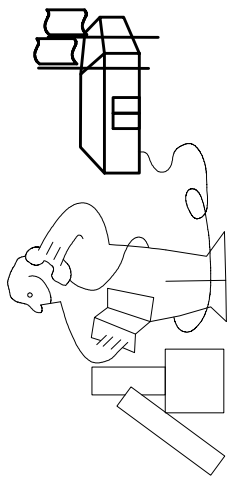
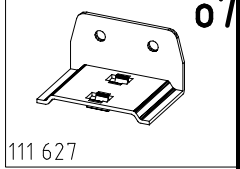
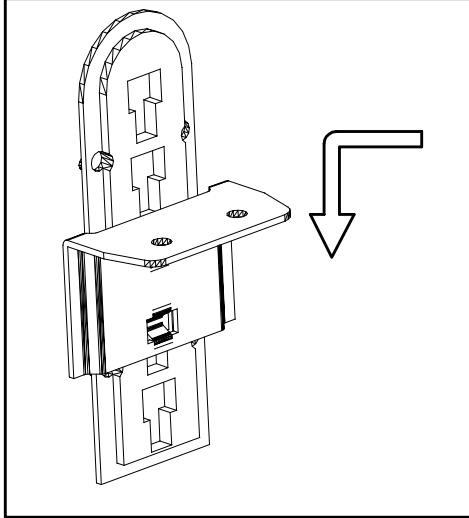
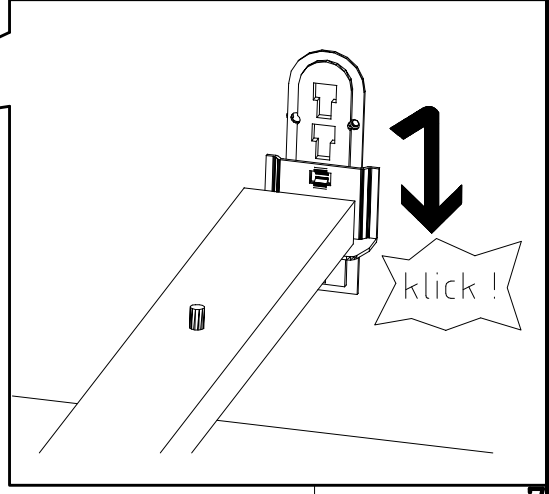
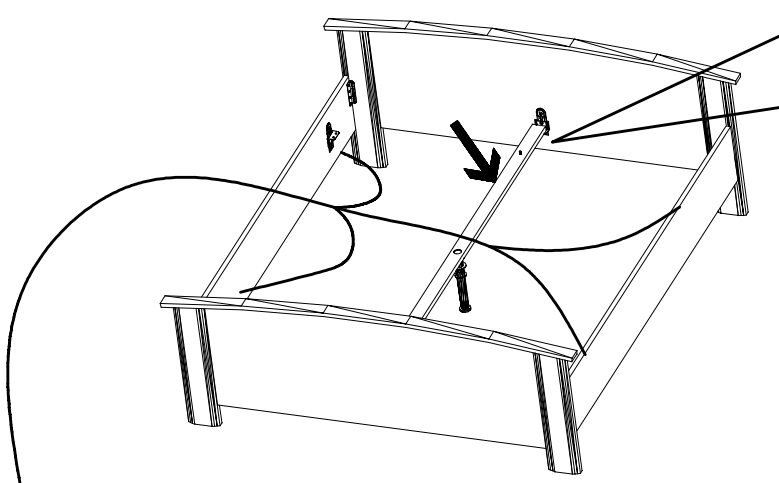

(121 370)	( G 1 )	(4x)

Änderungen die dem technischen Fortschritt geschuldet sind, behalten wir uns vor!  
 Bei nicht vorschriftsmäßiger und/ oder nicht fachmännischer Montage wird bei Personen- und/ oder Sachschäden keinerlei Haftung übernommen.

WIMEX Wohnbedarf/ Import Export Handels GmbH/ Postfach 1407/ 49112 Georgsmarienhütte/ Germany  
 Tel.:(+49) 054-01 8598 16/17 Fax.:(+49) 054-01 8598 33 Mail: info@wimex-wohnbefarf.de