

system LABIRYNT

LA 22

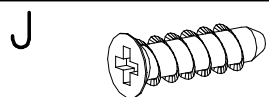

J
6,3 x 16 x12

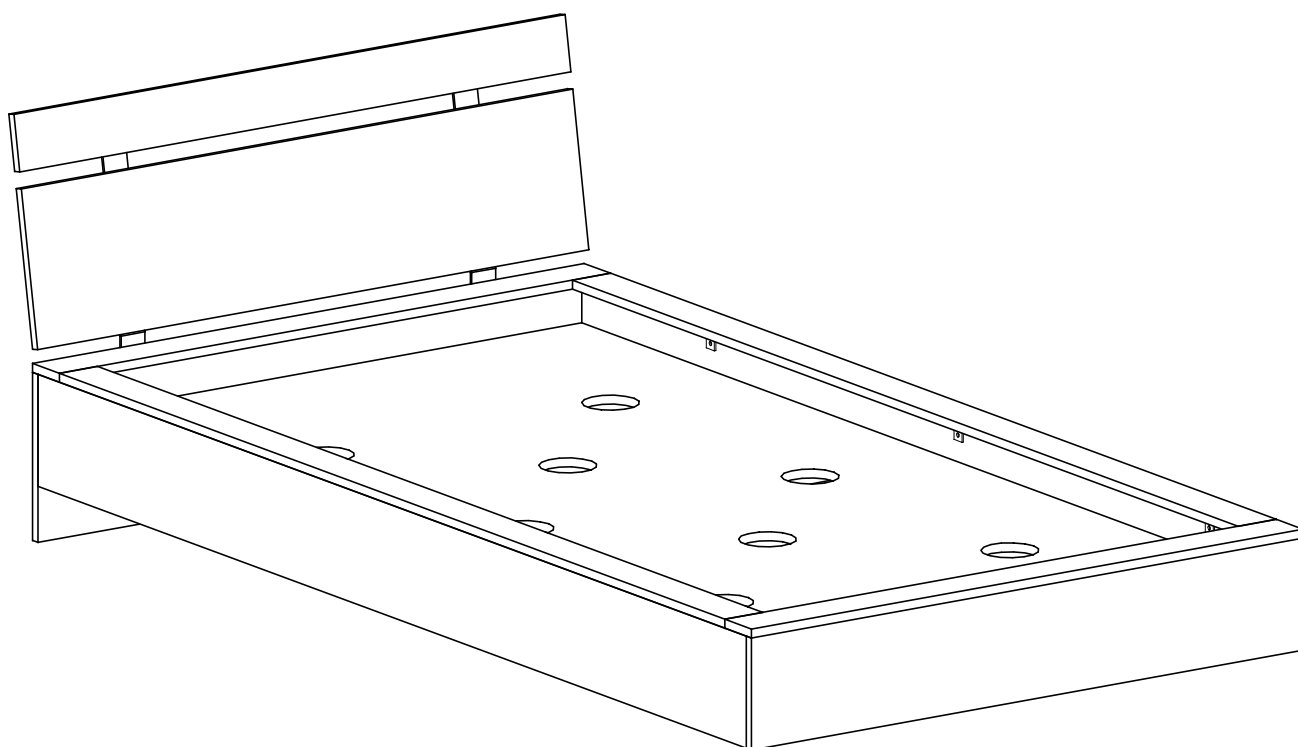
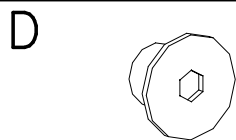

D
x4

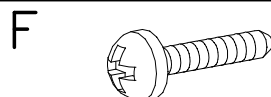

F
M6 x 14 x4

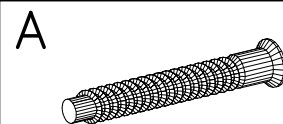

A
x2



W
x3

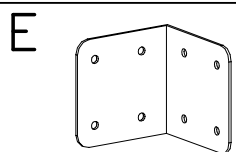

E
x12

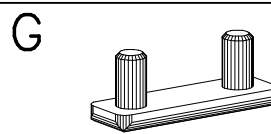

G
x8

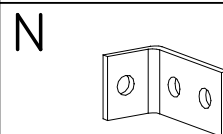

N
x10

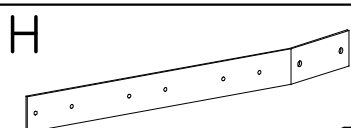

H
x2

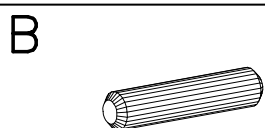

B
x44

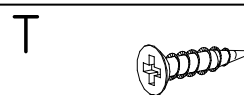

T
4 x 16 x126

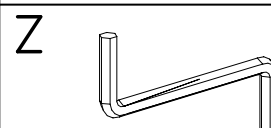

Z
x1