

980888

1.

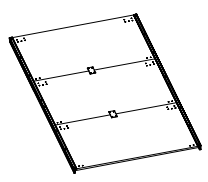

2.

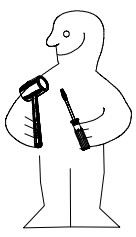
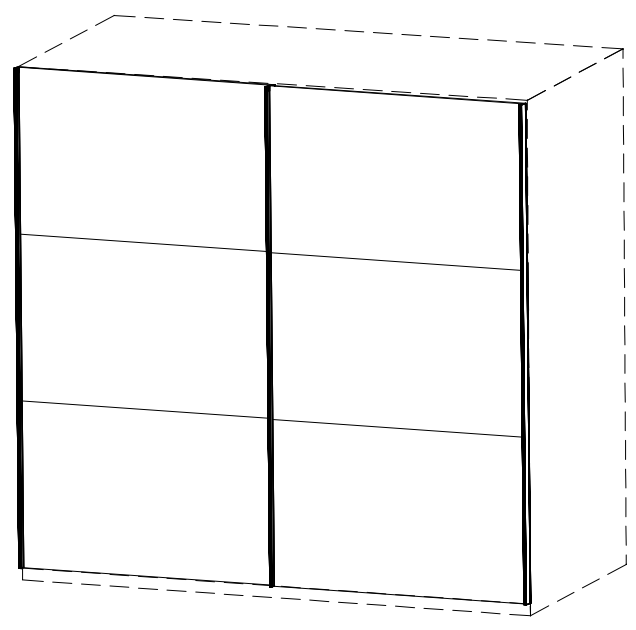
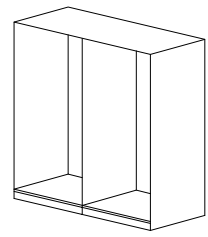

NSP/SHS

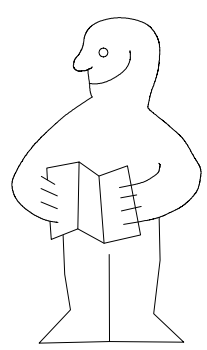
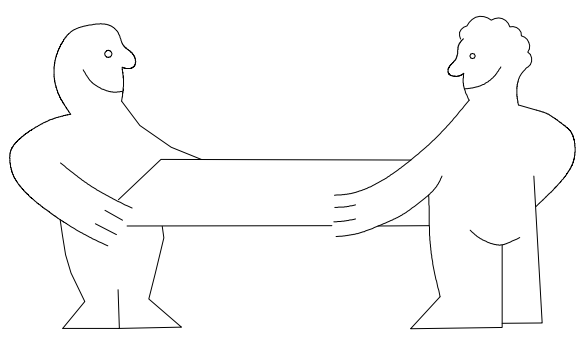
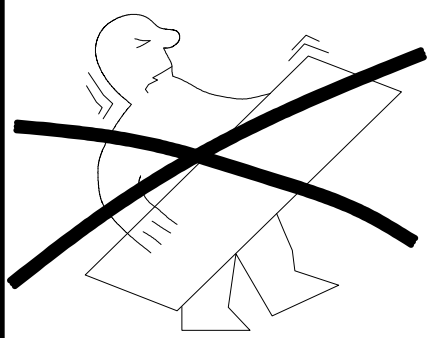

1-2-3-4... ○

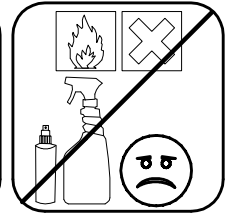
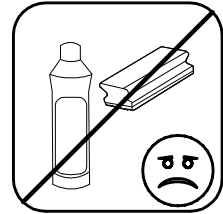
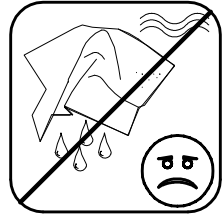
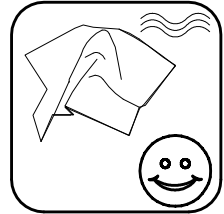
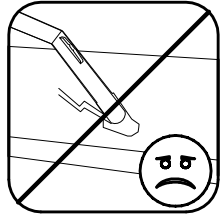
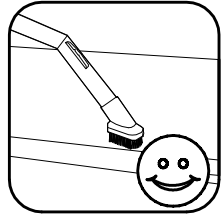
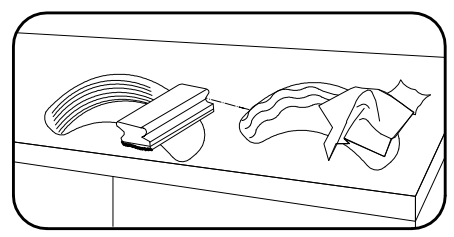
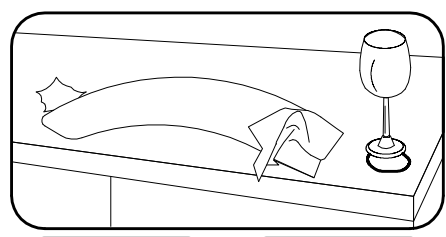
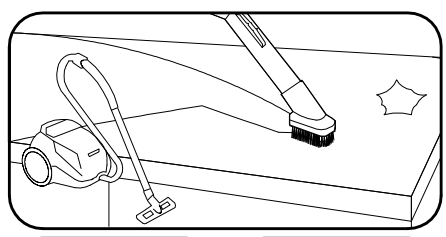
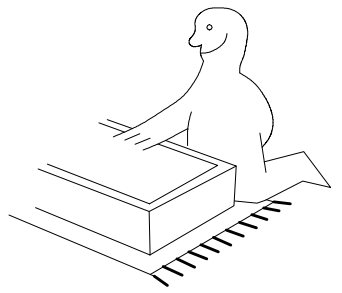
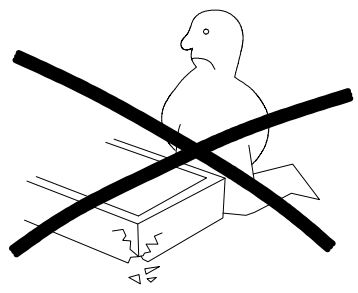
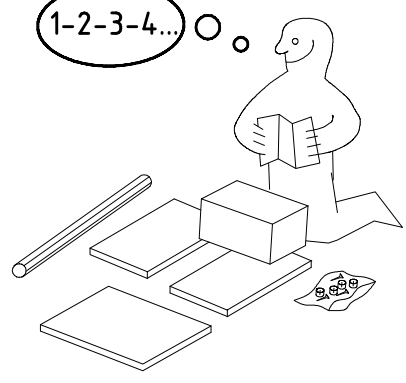

980888

16.07.13 / 07.03.14

03 14

1/6

1x
FPN

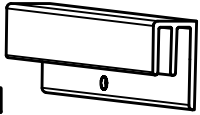

1316/
1760/2204/2648/3092

1x
LP

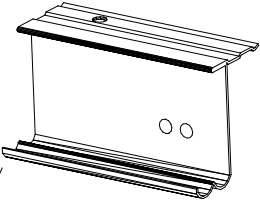

1316/
1760/2204/2648/3092

	SWH1	2x
	SWH2	1x
	SWH3	1x
	SWH 6	2x
	SWH 7	2x

	SWH-D	1x
	SWH-SKL	1x
	SWH-SKR	1x
	SWH-ST	2x
	SWH-MS	2x

	SP13 4 X 13mm	64x
	G24 3,5 x 22 mm	80x
	T2 M6,3 x 10,5 mm	10x
	H5 111 030	24x
	H5 114 183	4x

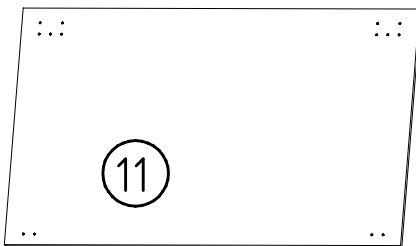
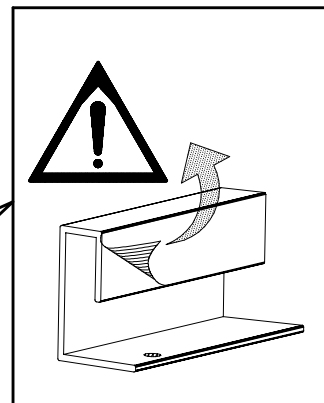
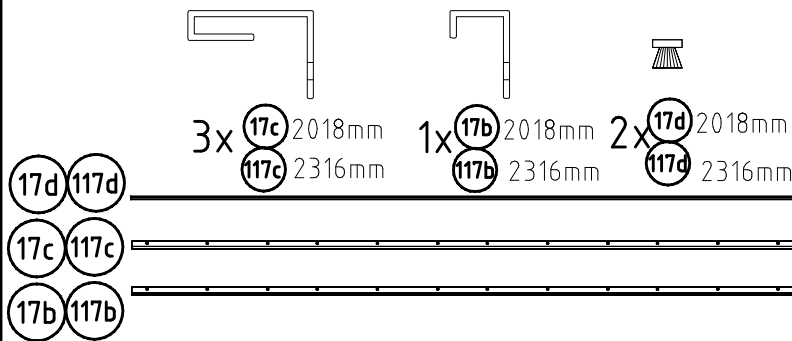
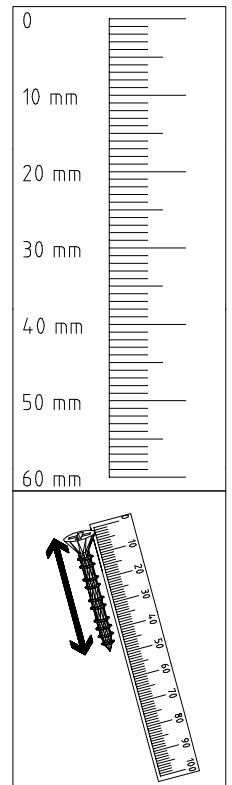
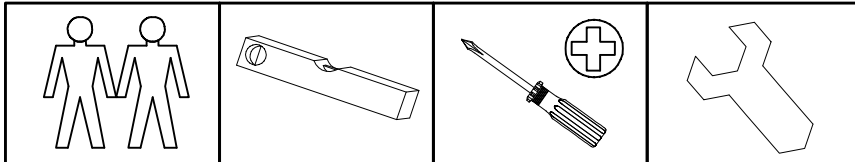
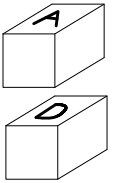

6x 1135 / 1357 x 673 x 15
6x 1135 / 1357 x 772 x 15

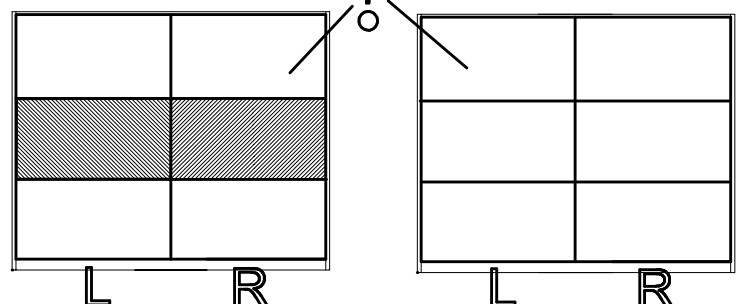
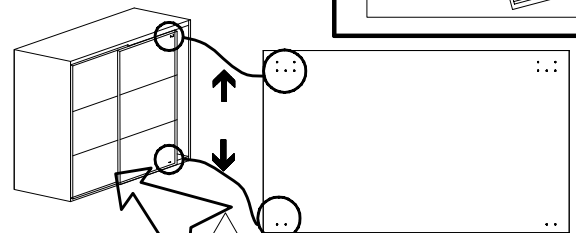

1

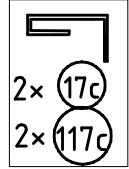
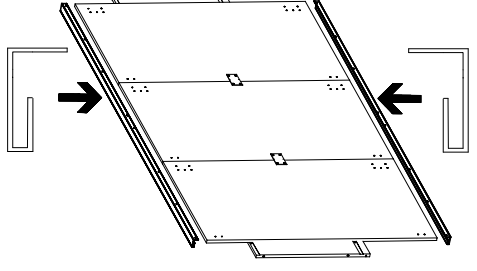
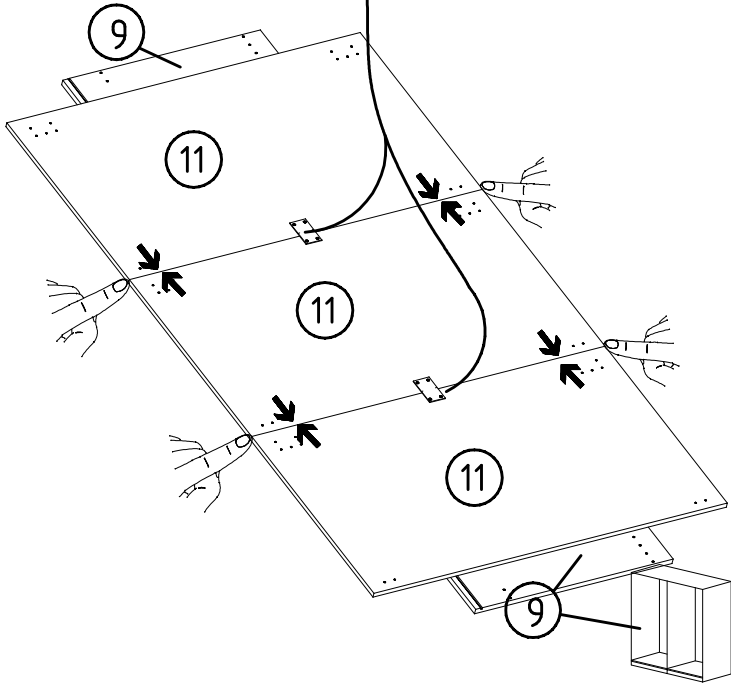
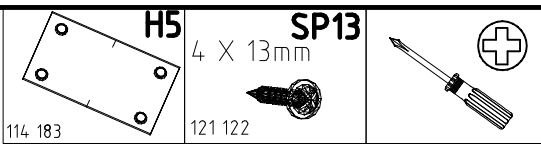
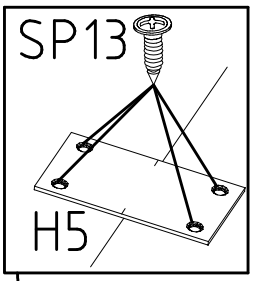
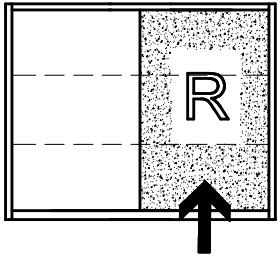

2

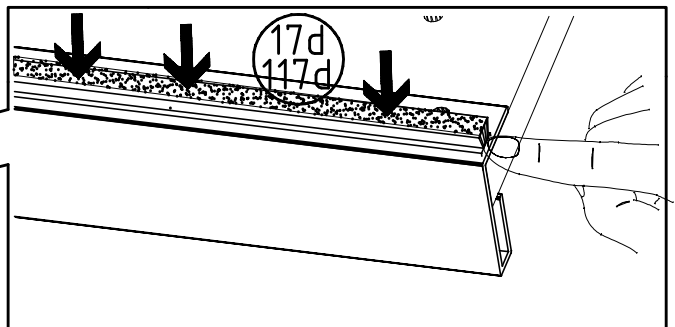
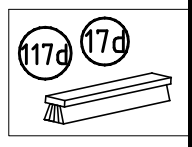
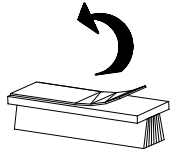
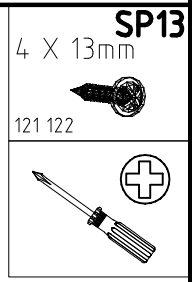
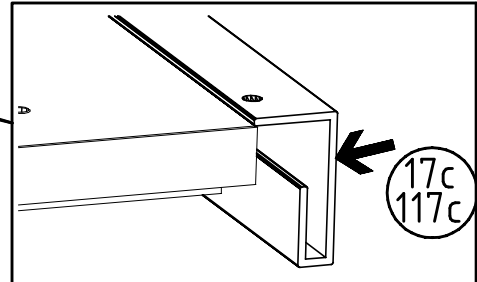
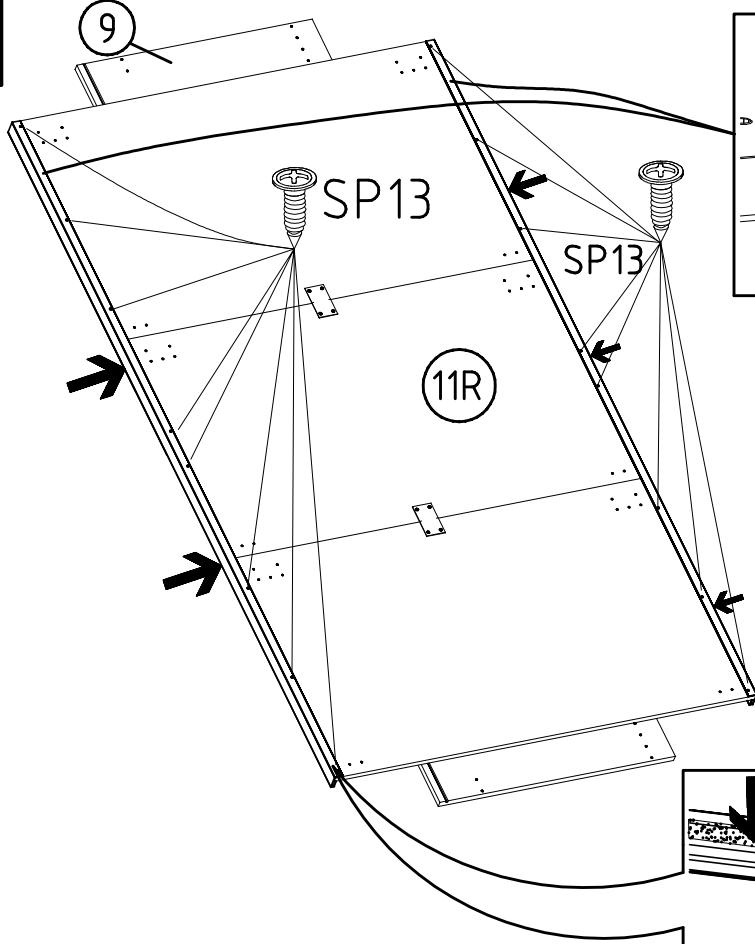

3

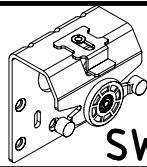

SWH1

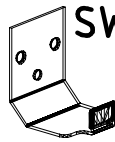

SWH6

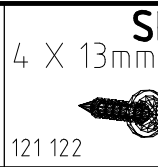

SP13

4 X 13mm

121 122

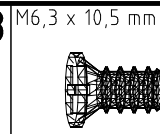

M6,3 x 10,5 mm T2

111 030

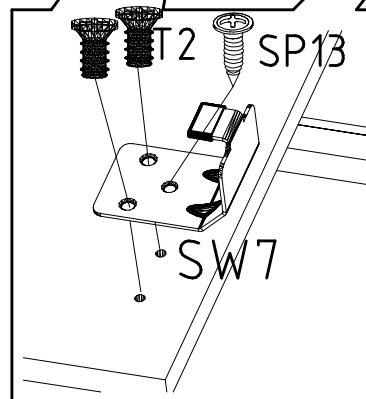
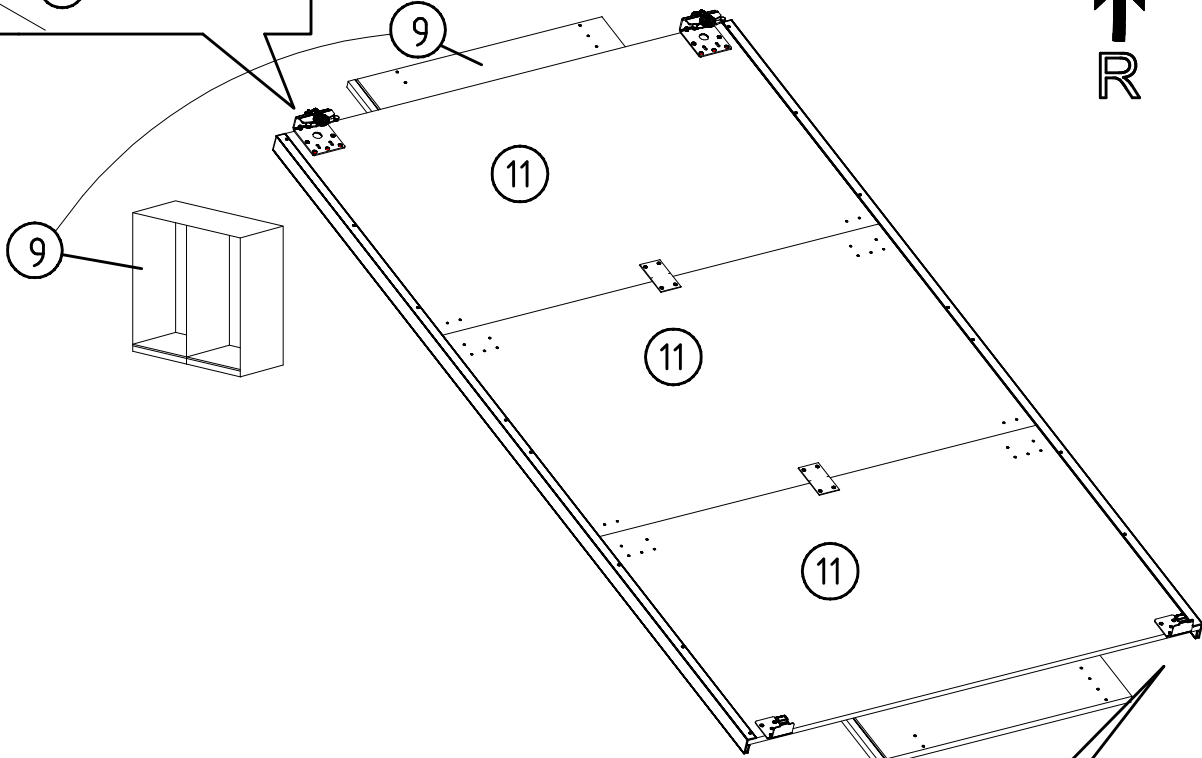
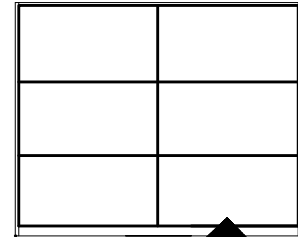
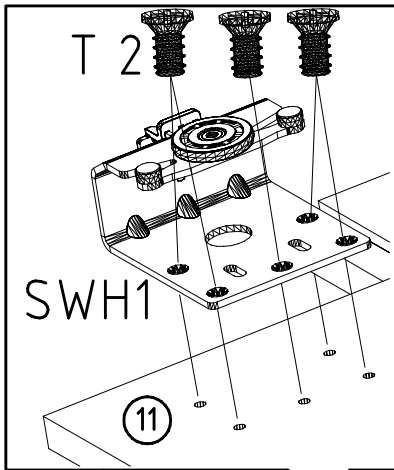
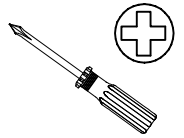

4

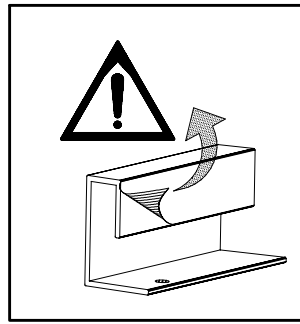
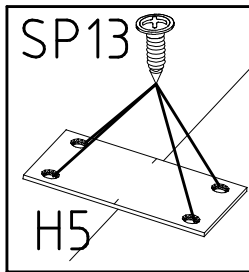
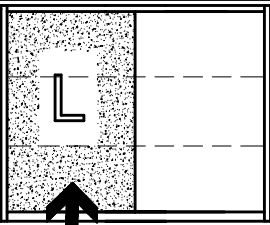

H5 4 X 13mm
114 183

SP13
121 122

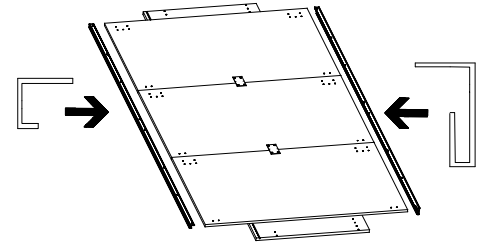
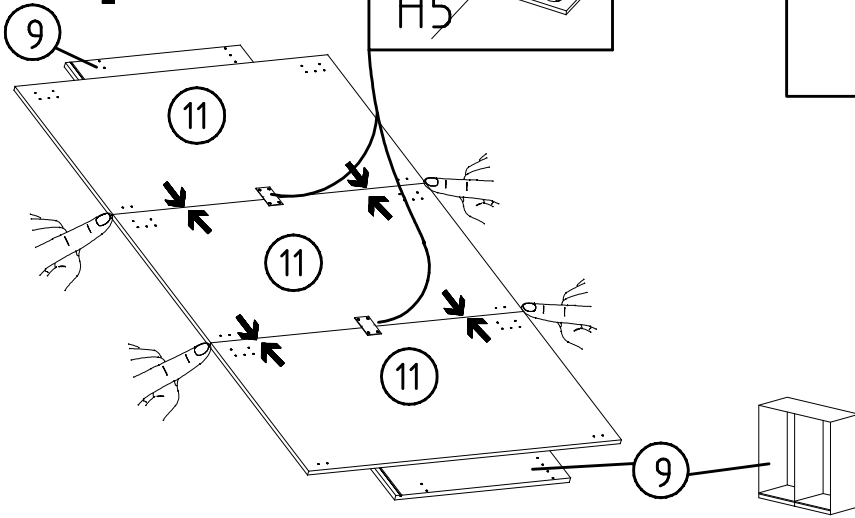

1x (17c) 1x (17b)
1x (117c) 1x (117b)

5

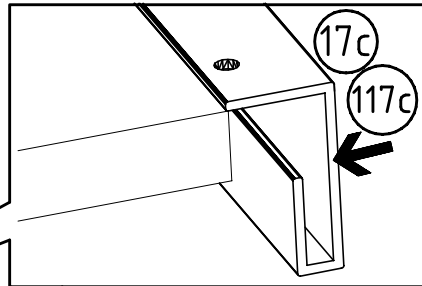
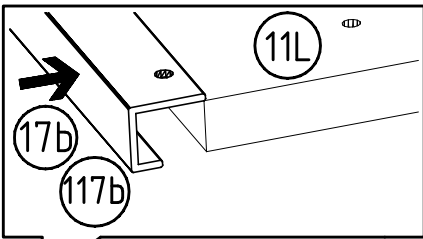

SP13 4 X 13mm
121 122

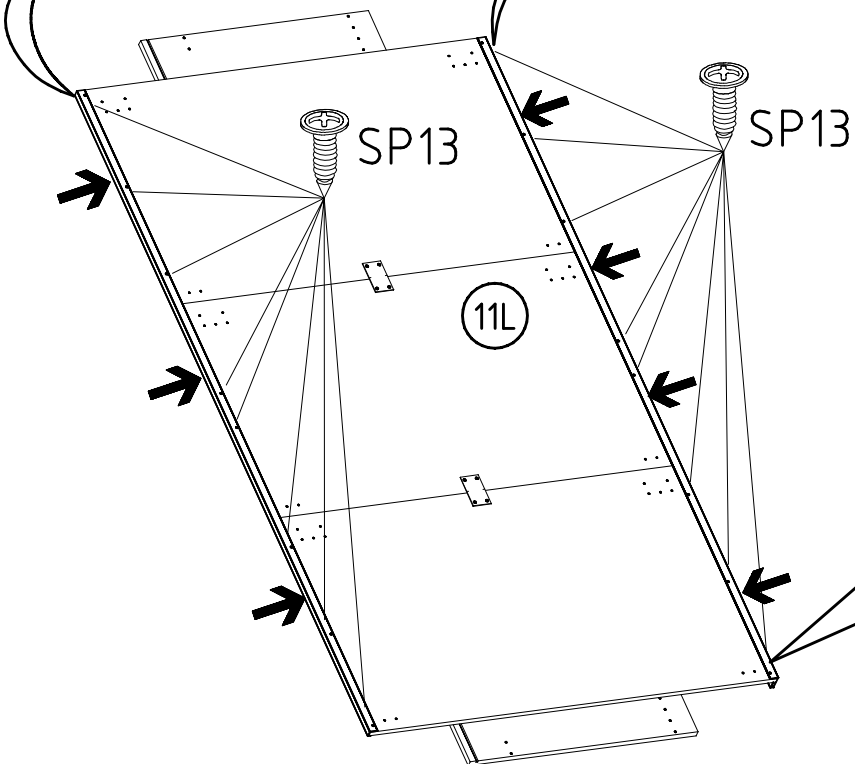

(117d) (17d)

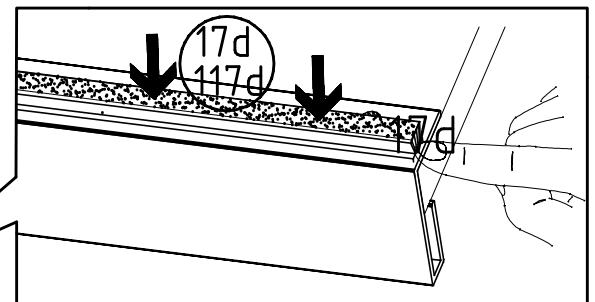
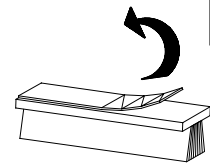

6

