

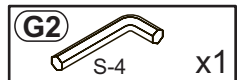

40 min.

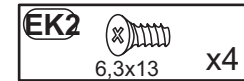

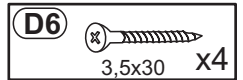
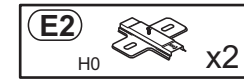
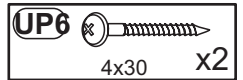
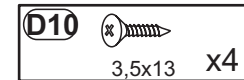
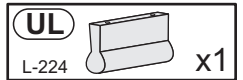
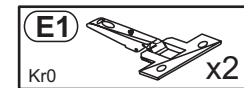
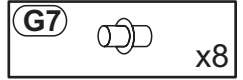
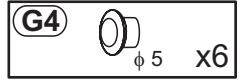
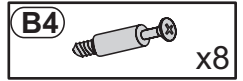
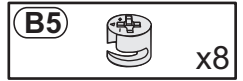
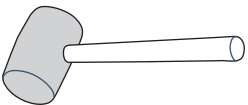
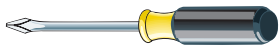
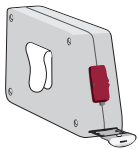
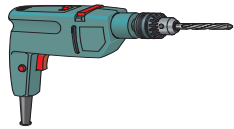
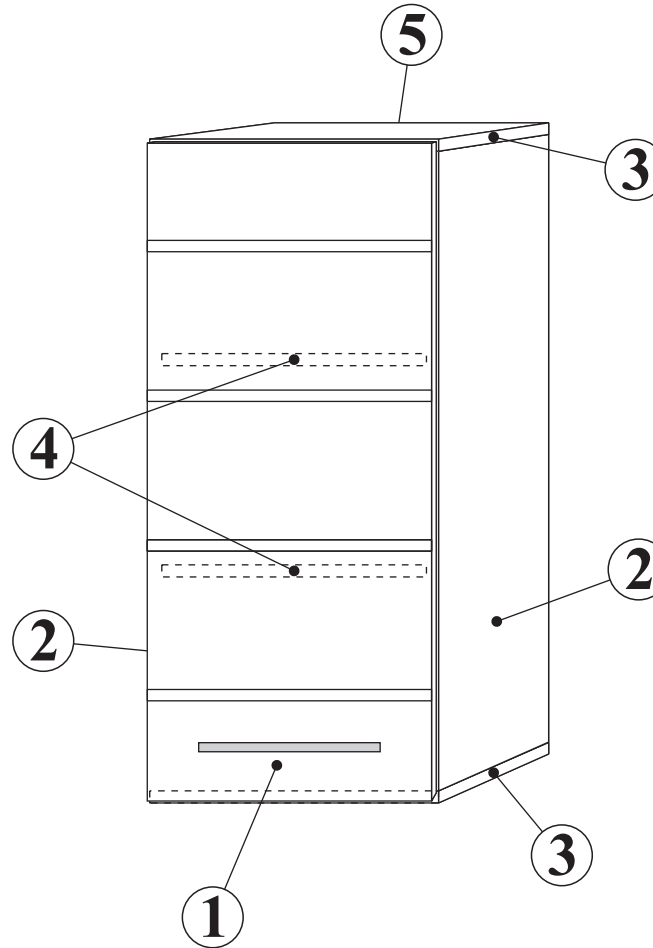
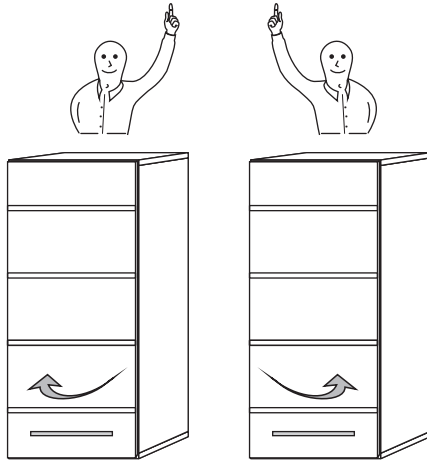
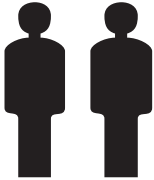
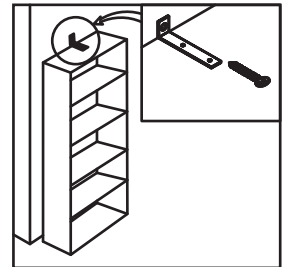
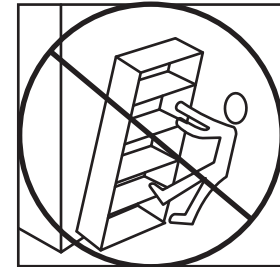
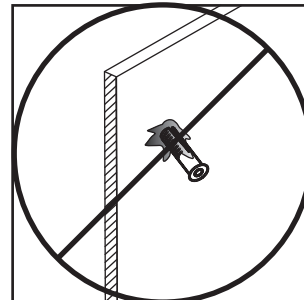
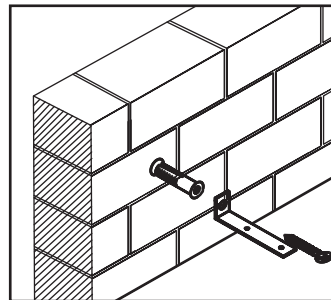
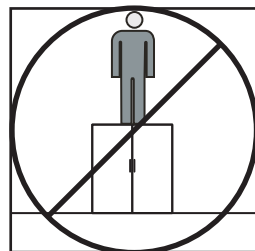
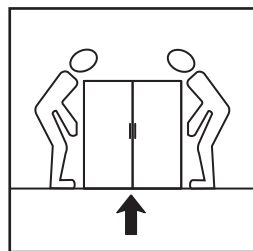
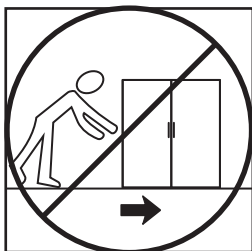
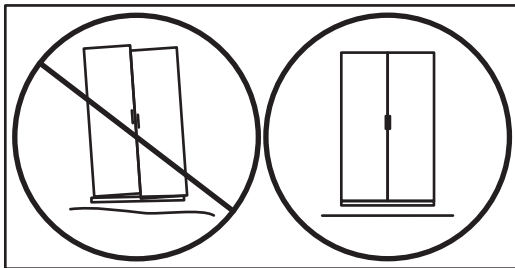
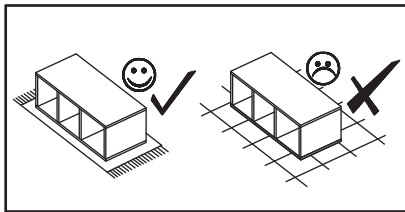
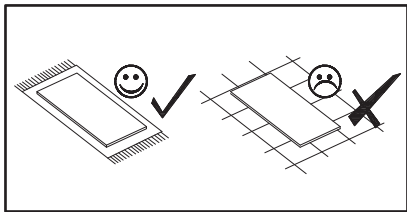
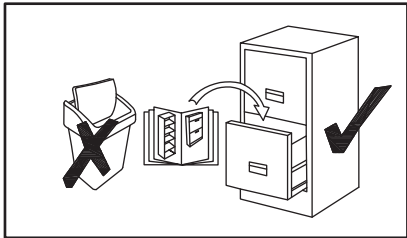
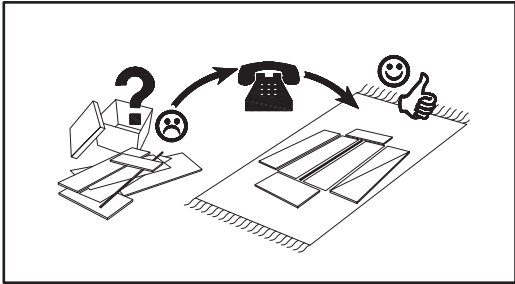

1

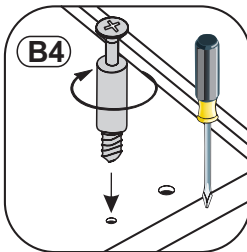
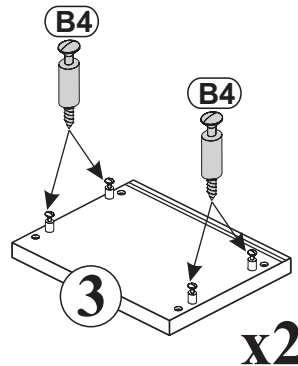
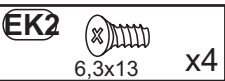
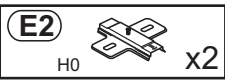
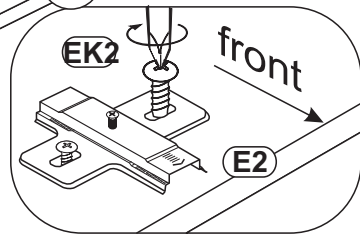
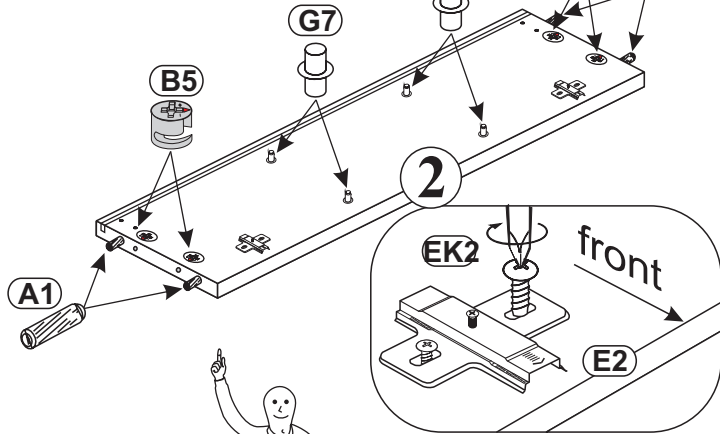
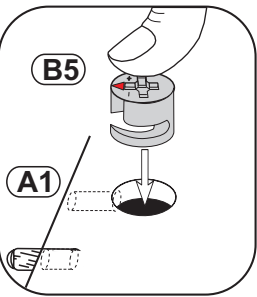
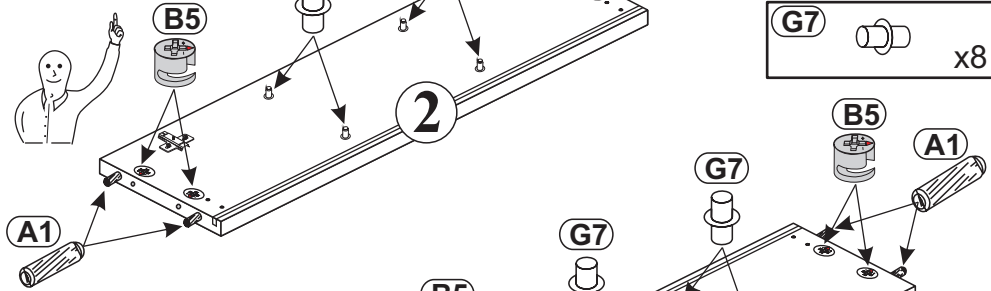
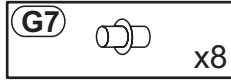
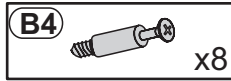
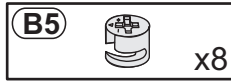
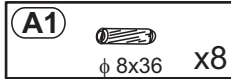
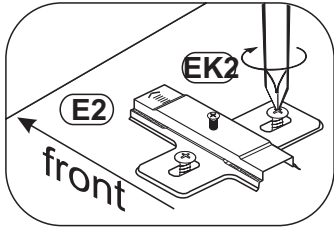

2

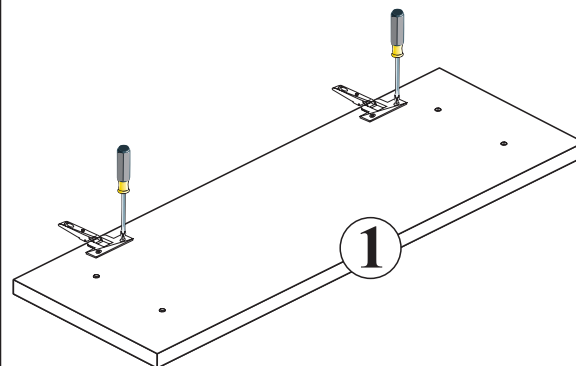
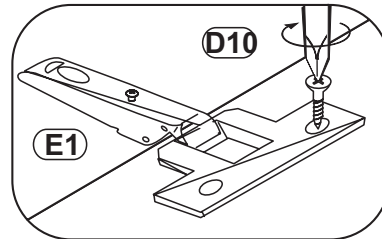
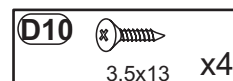
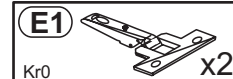

3

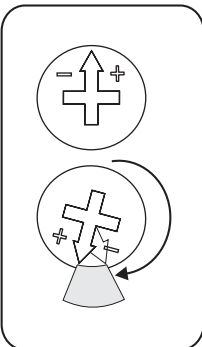
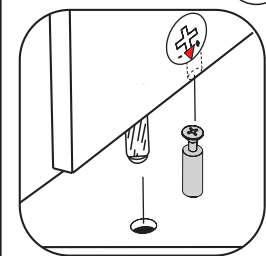
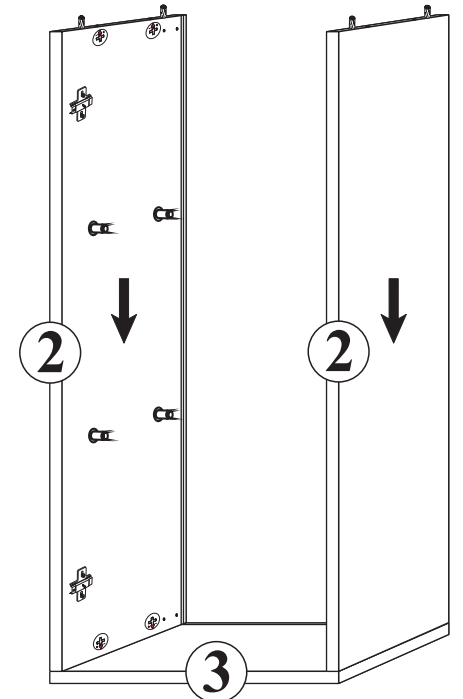

4

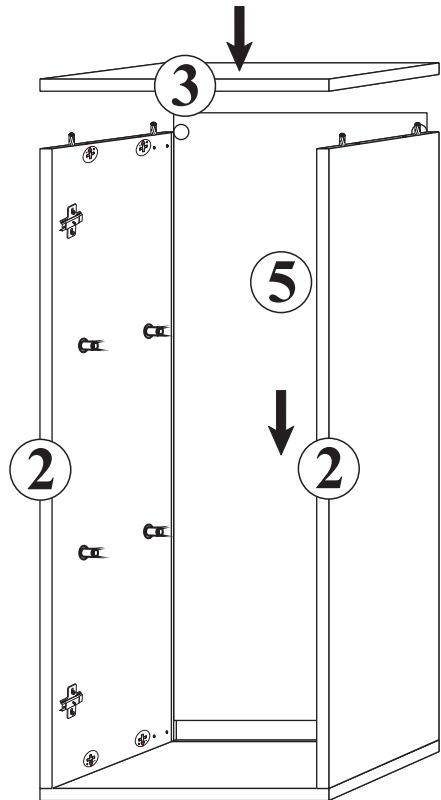
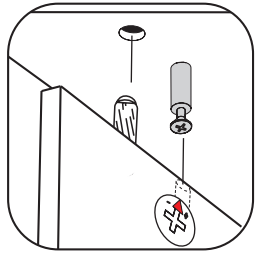

5



a=b

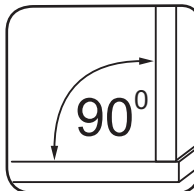
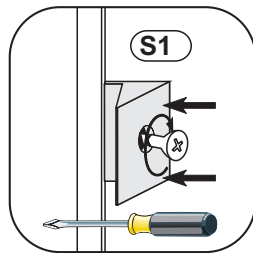
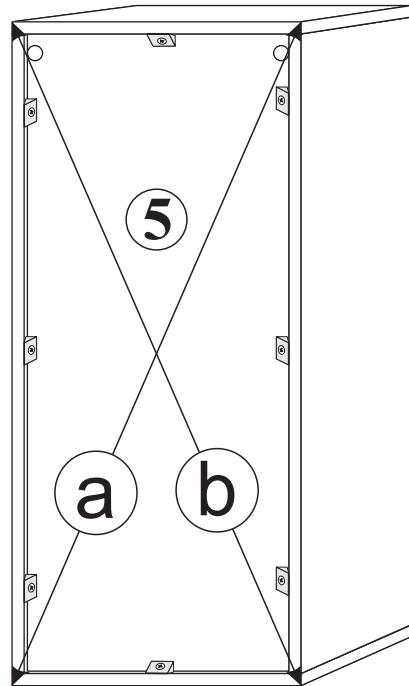

6

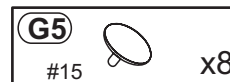
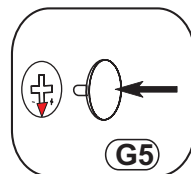
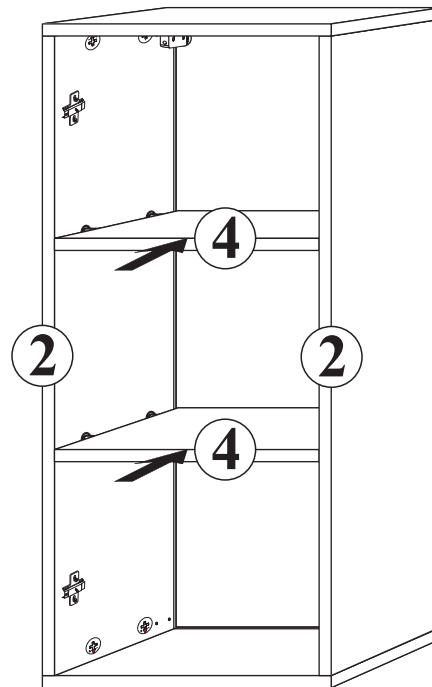
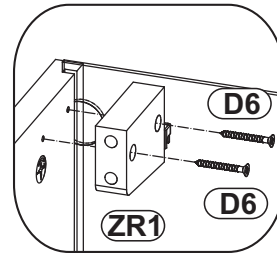
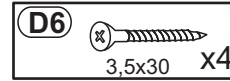
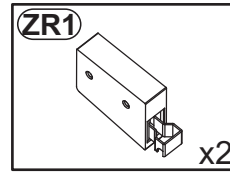

7

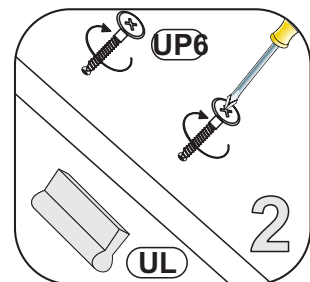
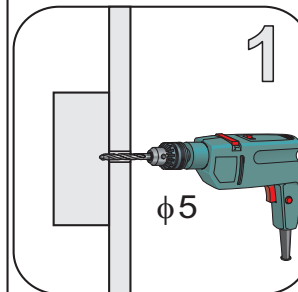
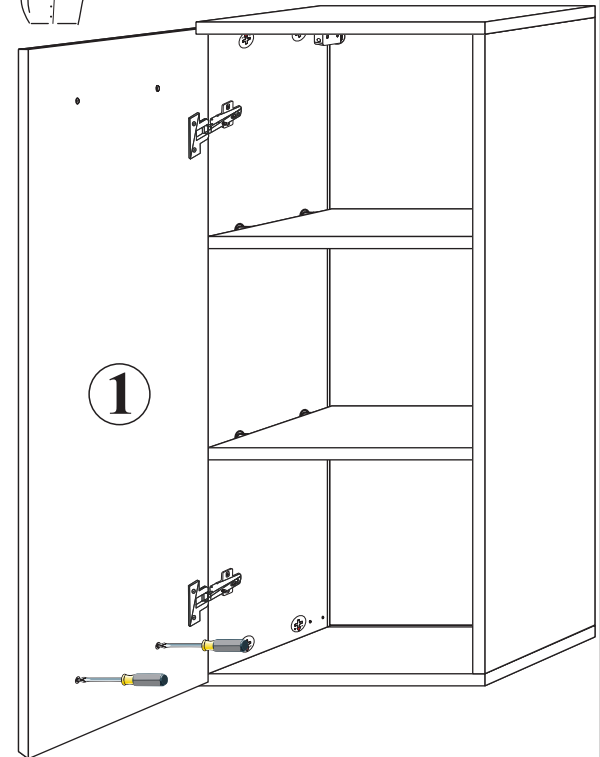
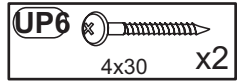
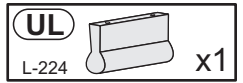
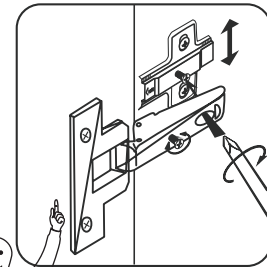

8

