

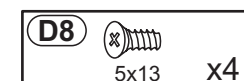

60 min.

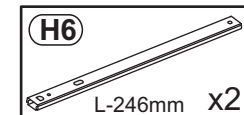

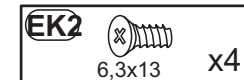
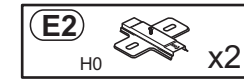
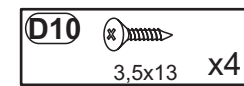
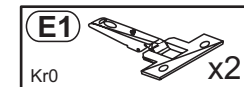
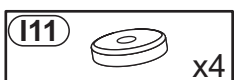
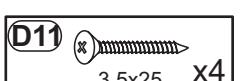
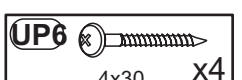
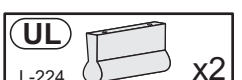
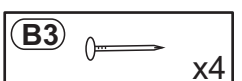
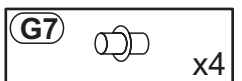
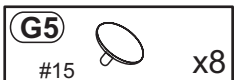
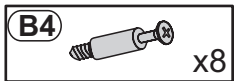
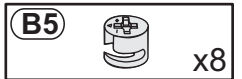
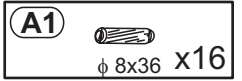
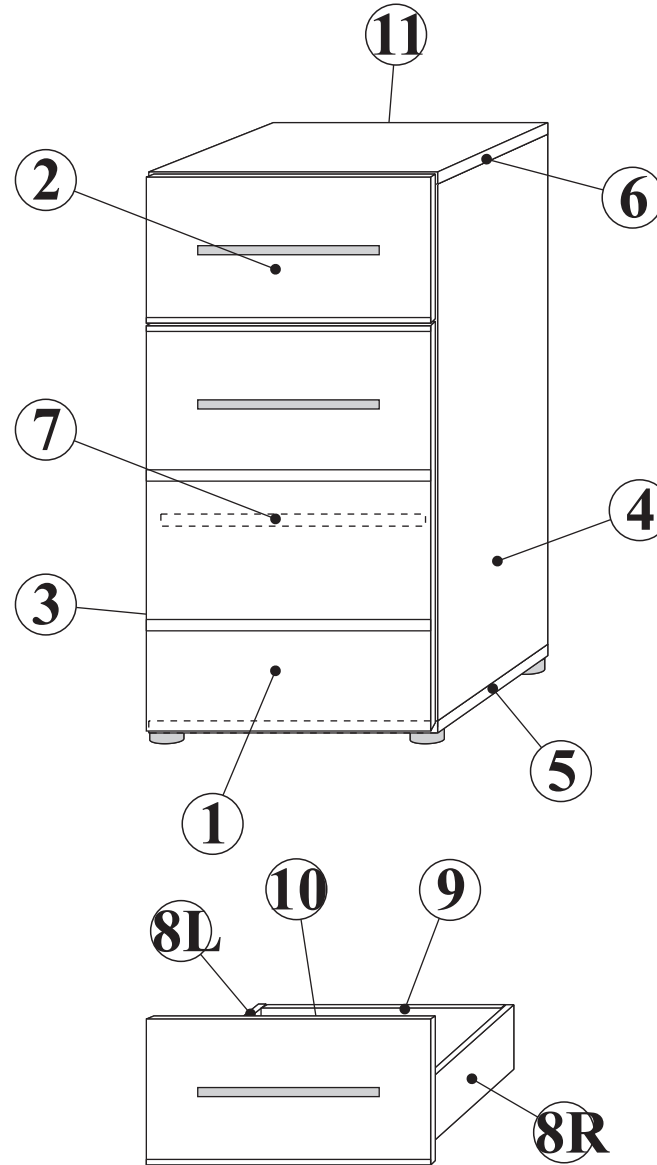
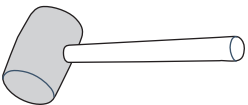
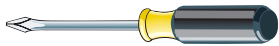
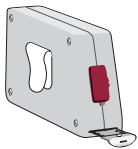
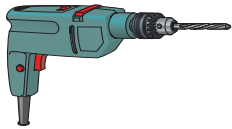
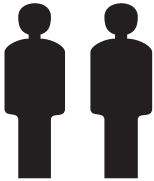
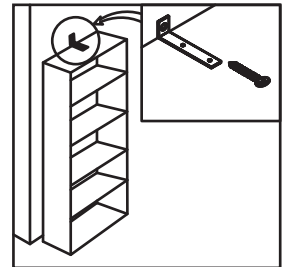
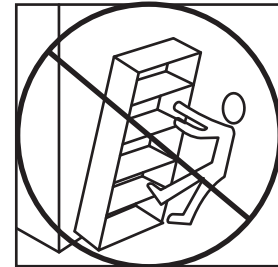
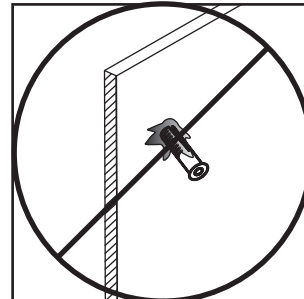
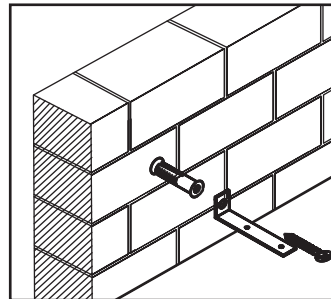
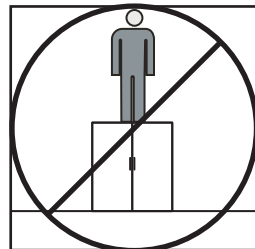
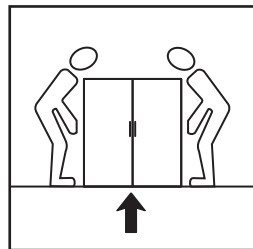
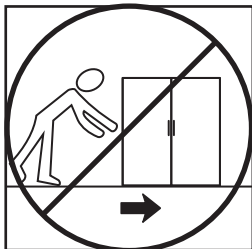
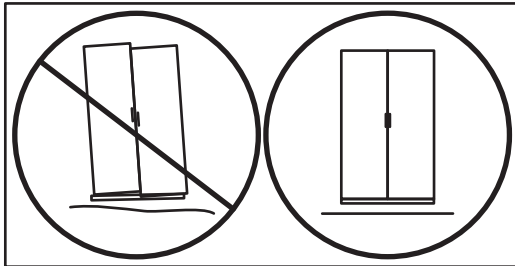
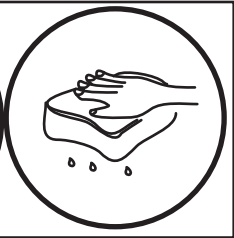
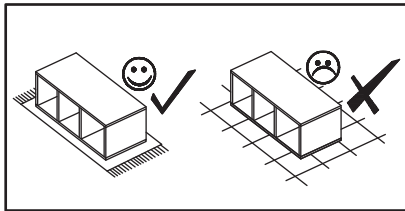
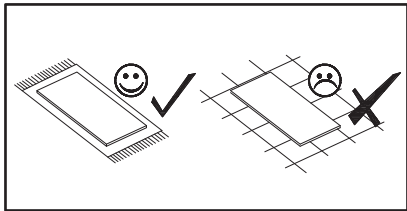
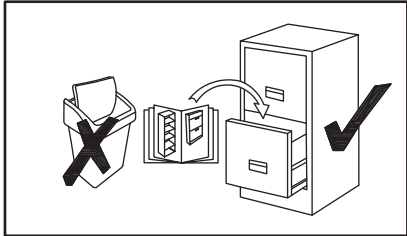
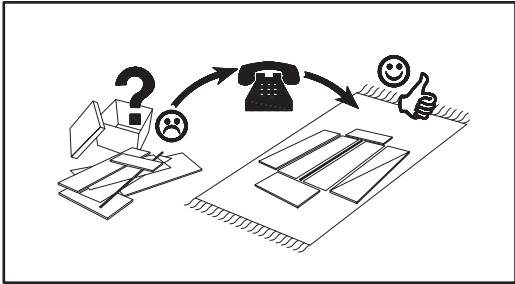

1

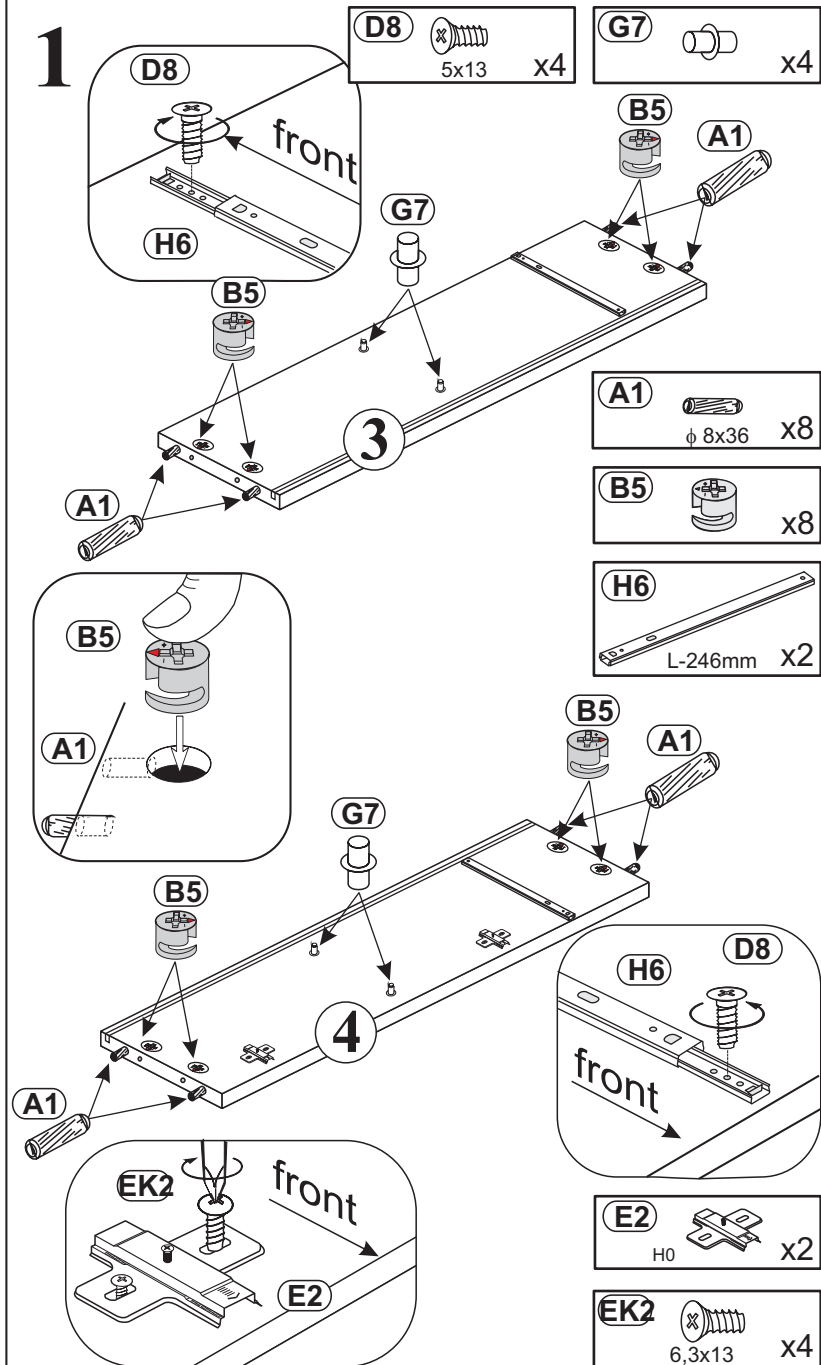

2

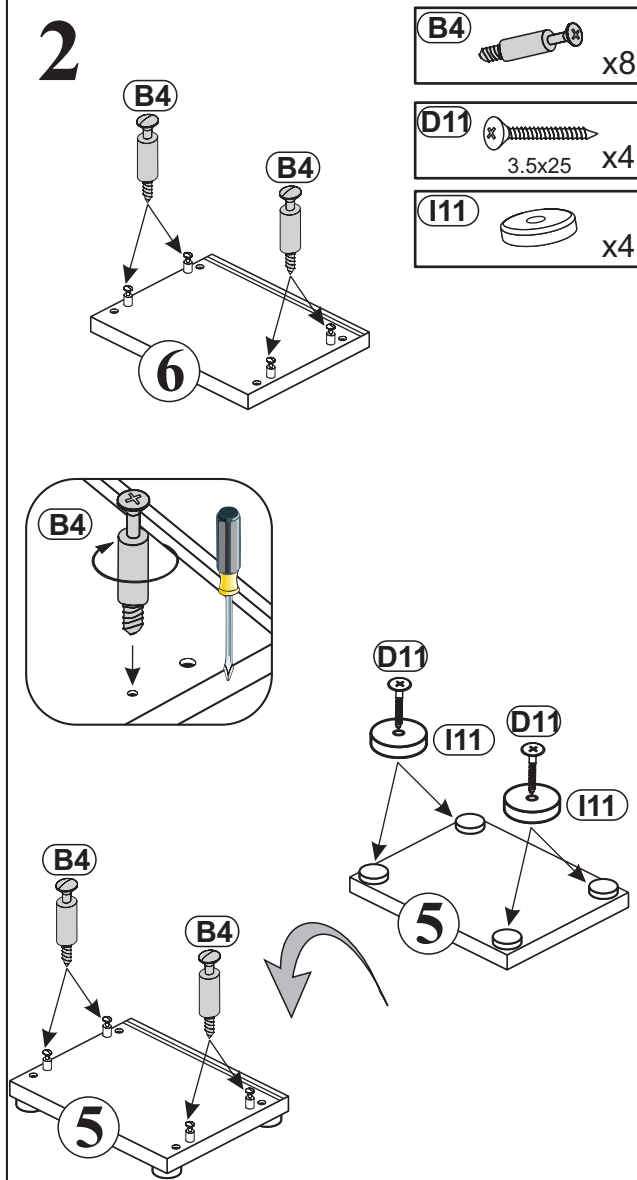

3

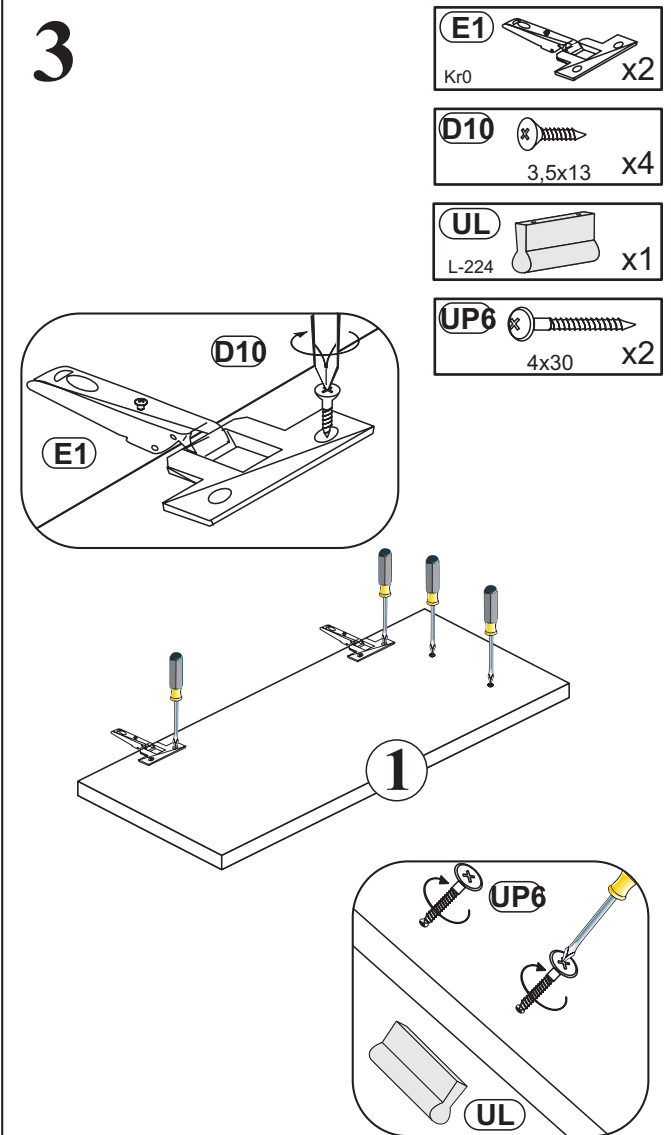

4

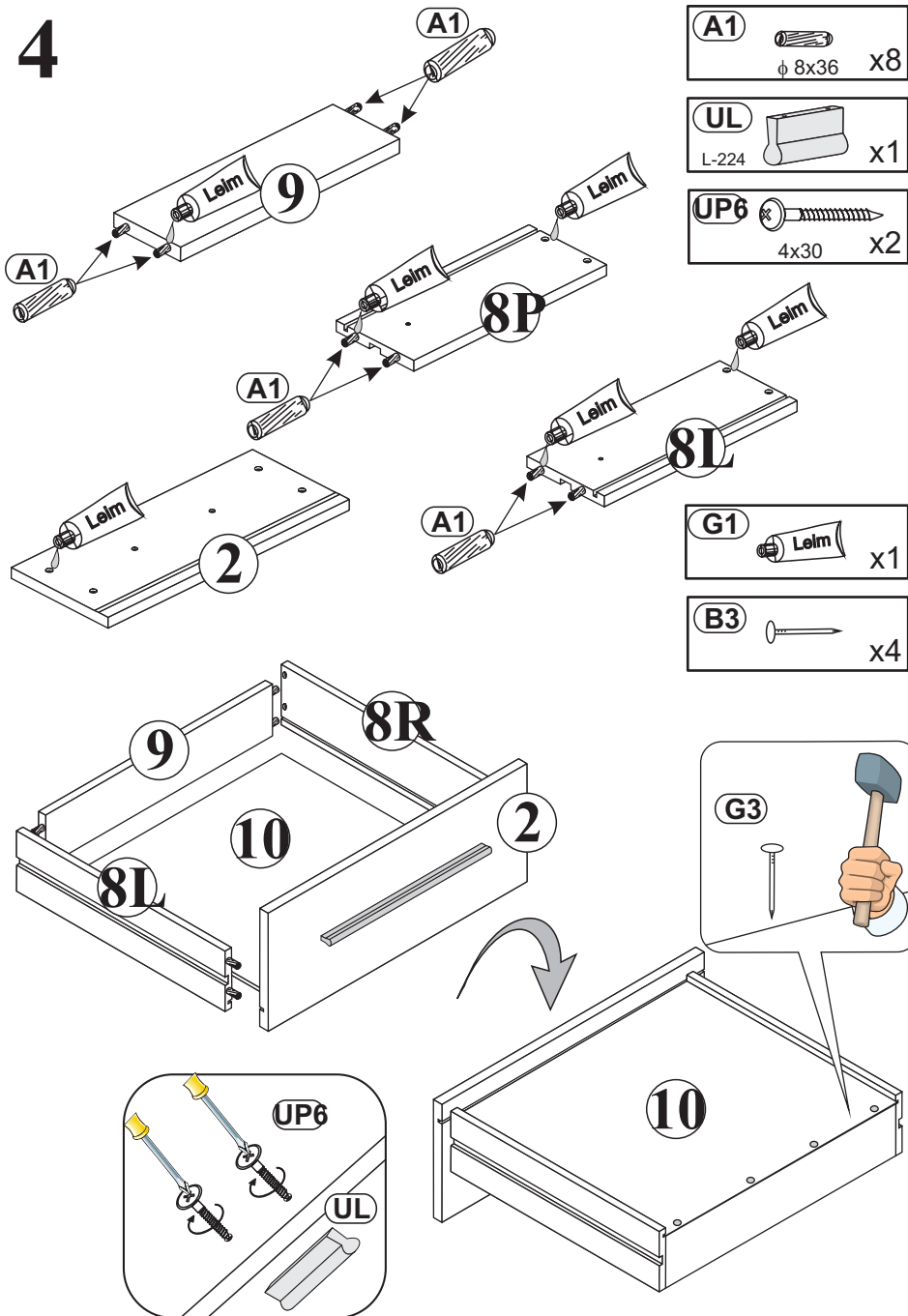

5

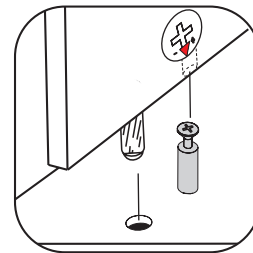
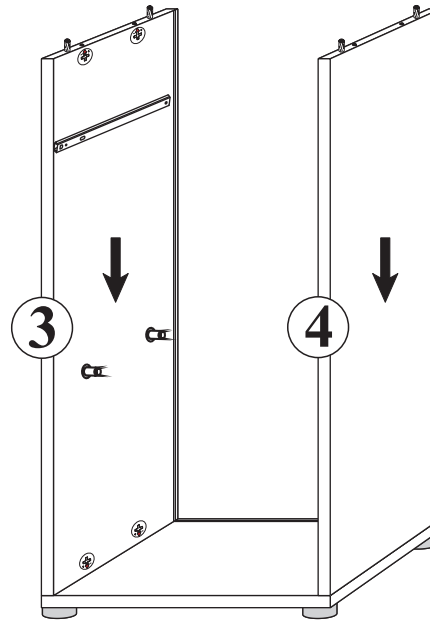

6

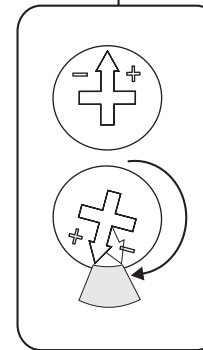
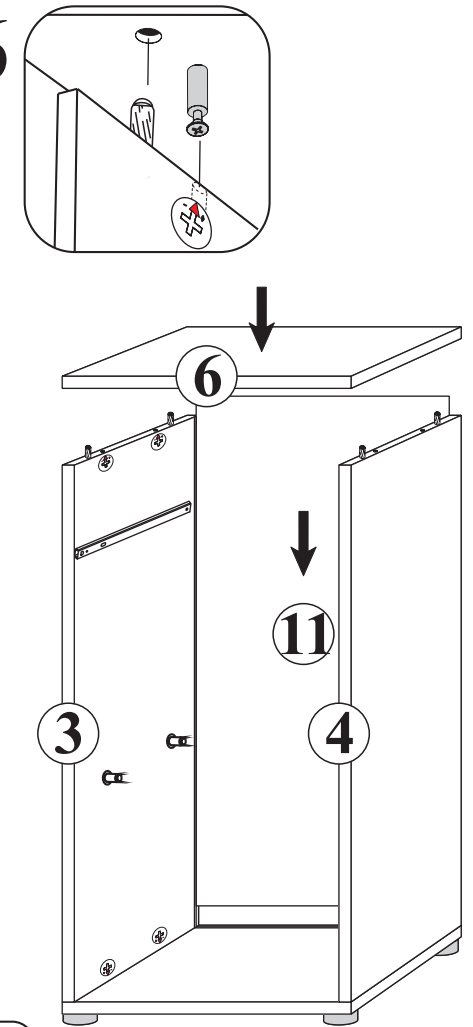

7



a=b

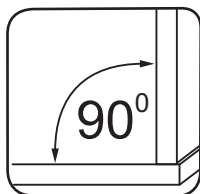
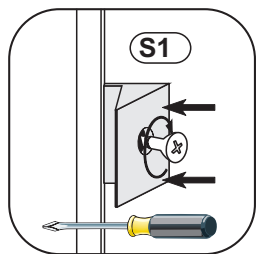
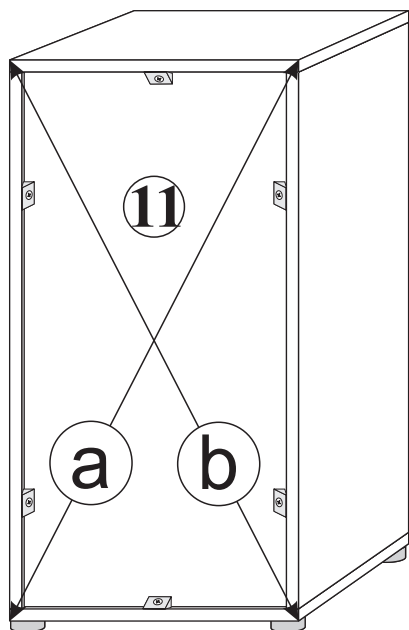

8

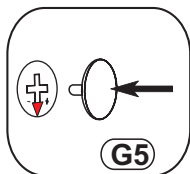
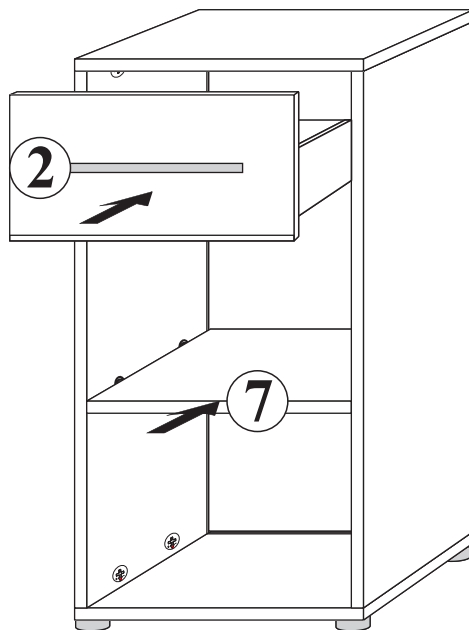
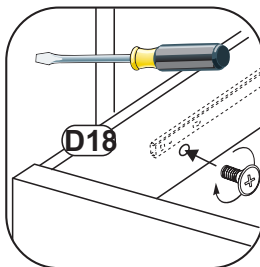

9

