

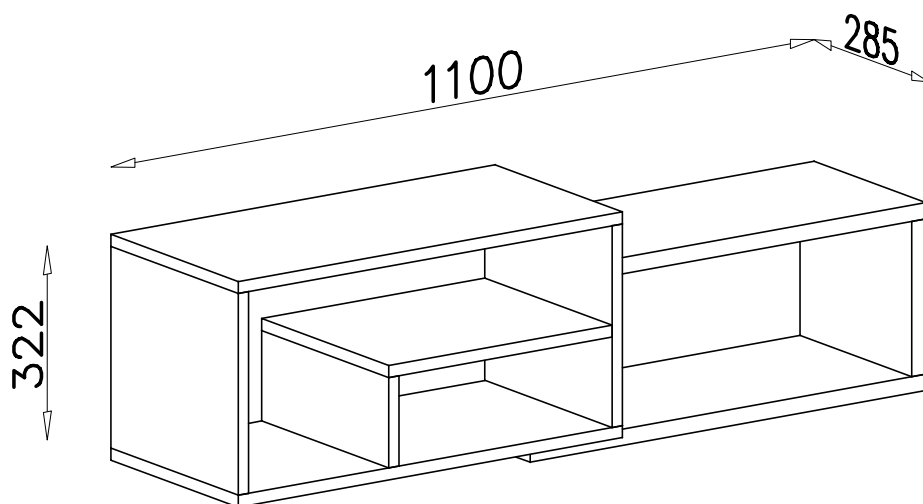

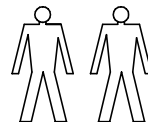

ETNA ET 12

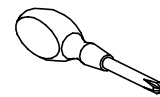

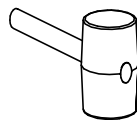
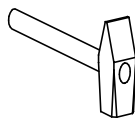
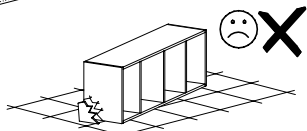
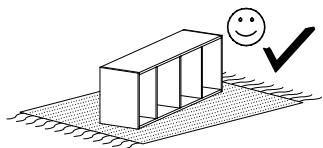

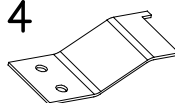
G2 
 3x20 x25

G3 
 4x30 x4

U14 
 x2

A5 
 $\varnothing 7 \times 60$ x2

B8 
 $\varnothing 8 \times 20$ x2

A1 
 $\varnothing 7 \times 50$ x8

B7 
 $\varnothing 8 \times 30$ x20

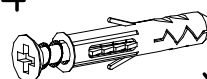
U4 
 x4

S2 
 x3

W1 
 GLUE, LEIM, LEPIDLO, LIM x1

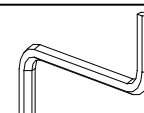
W2 
 x1

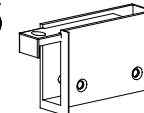
U13 
 x2

I

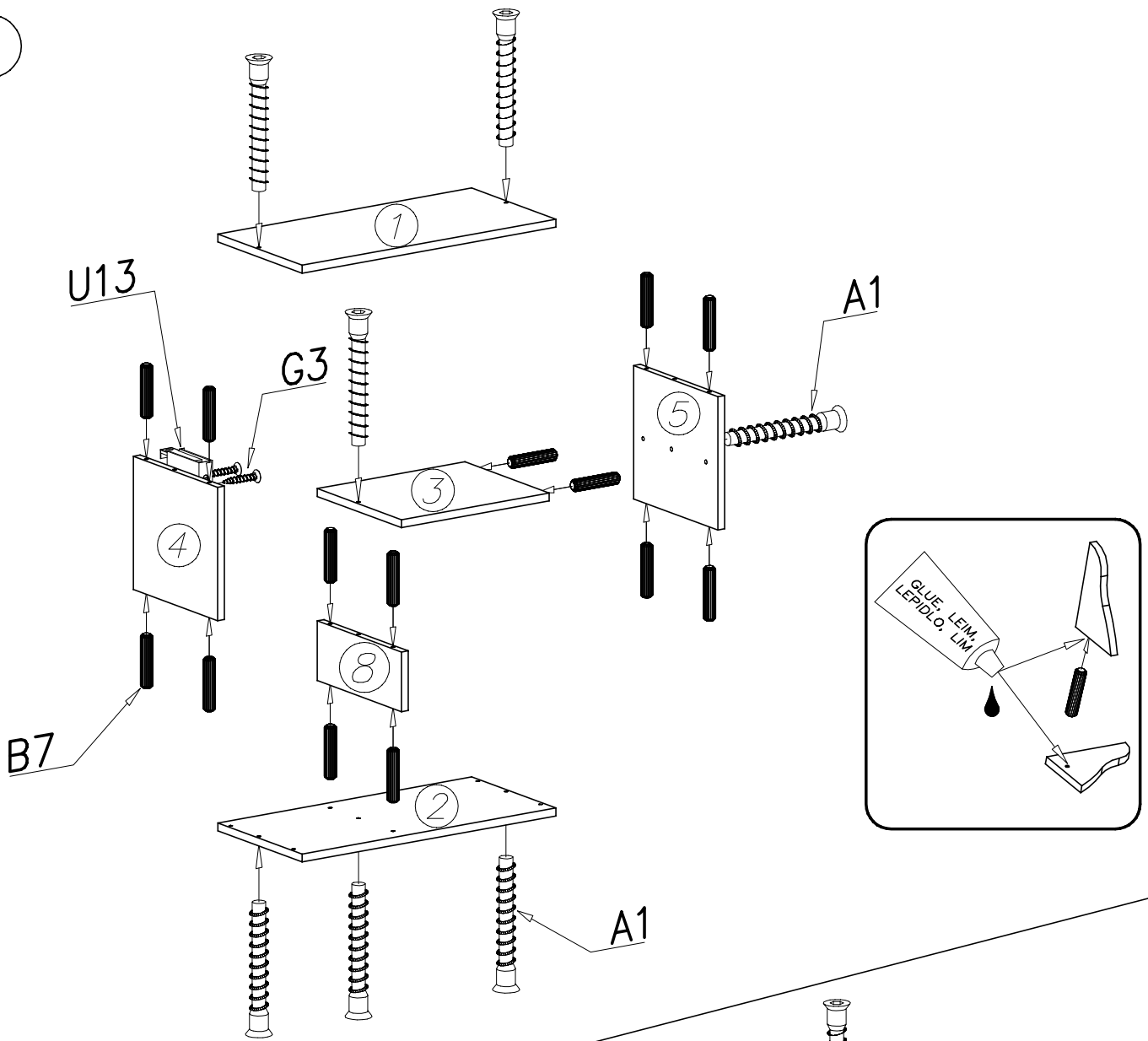

II

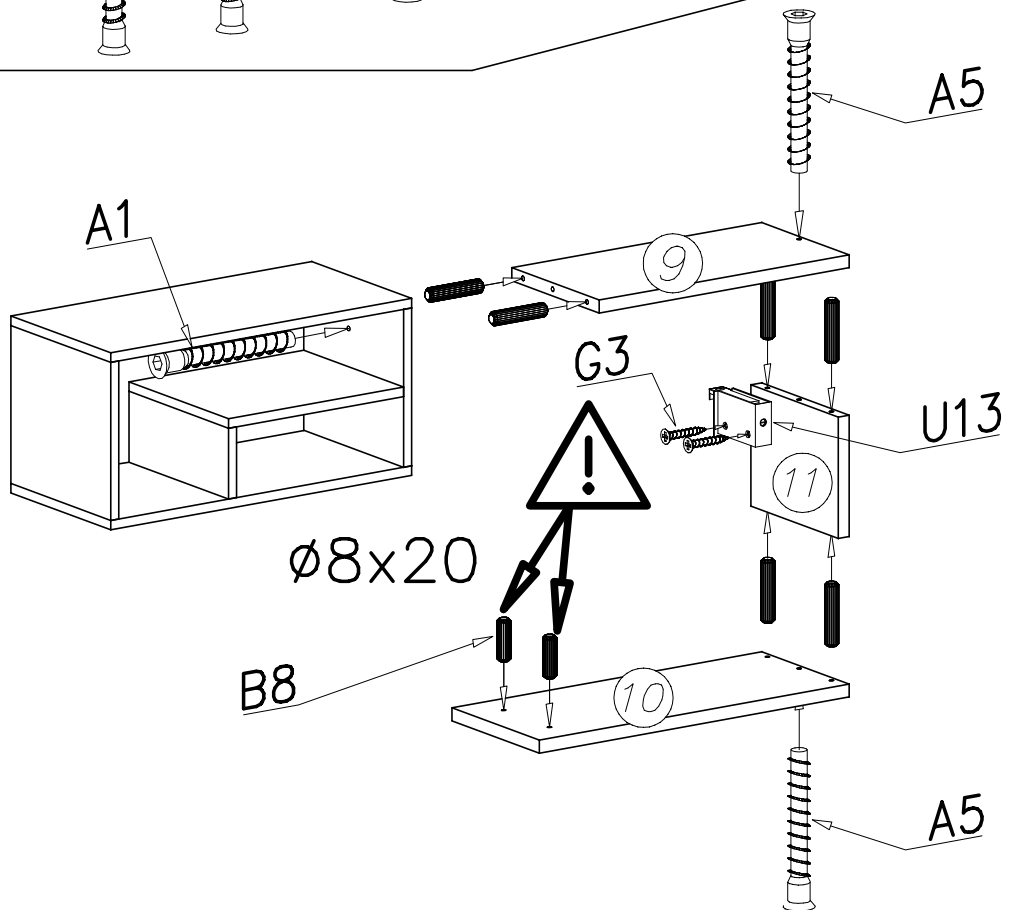

III

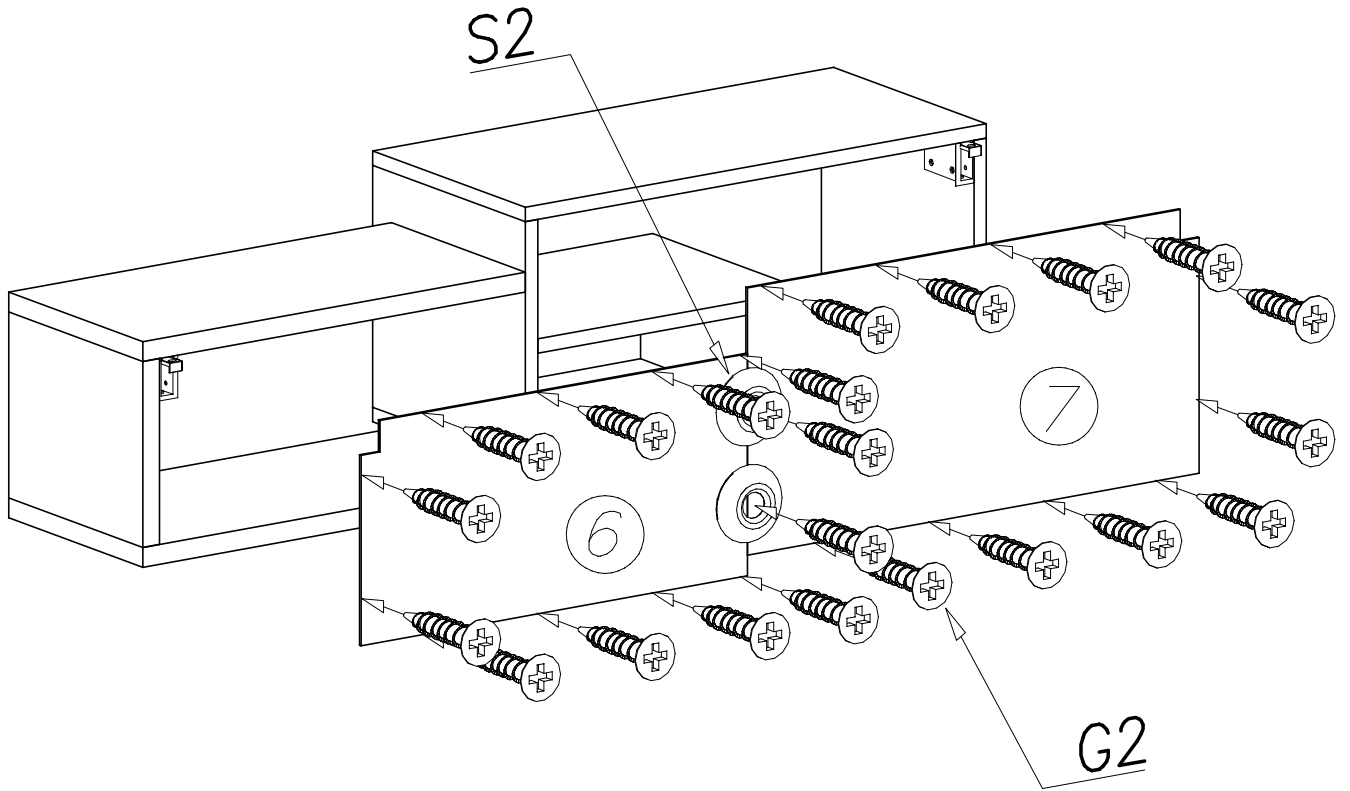

IV

