

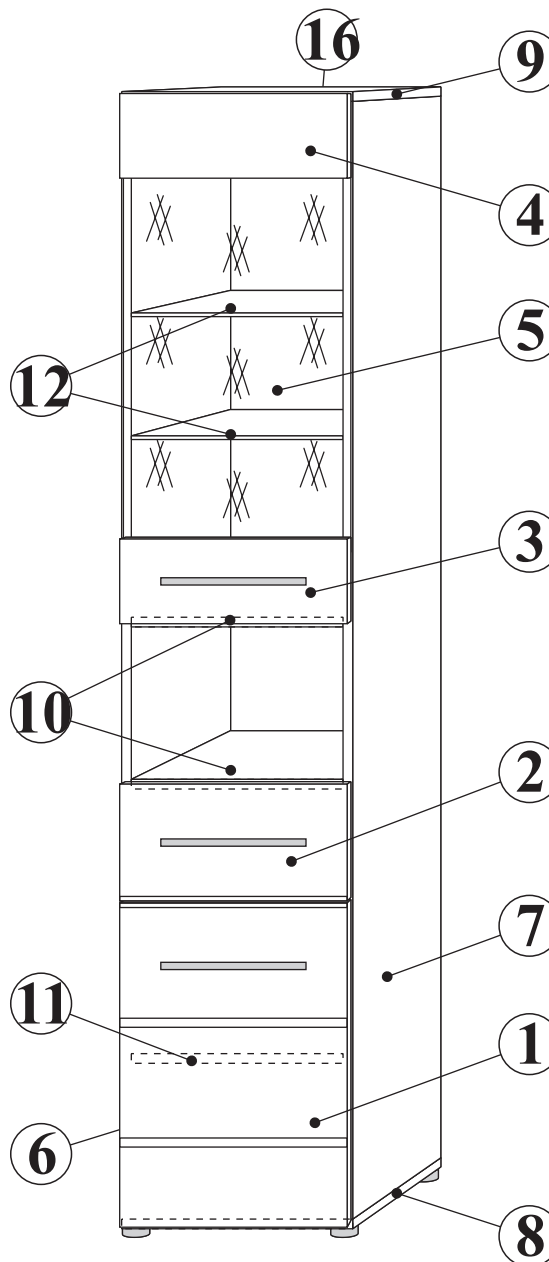

90 min.

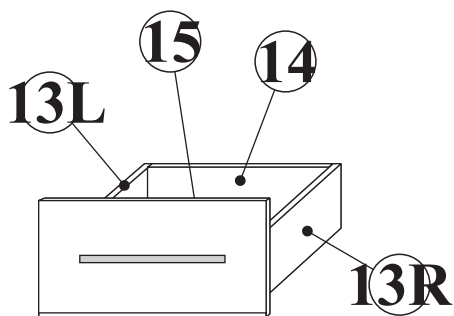

- | | |
|--------------------------|-------------------------|
| A1
φ 8x36 x24 | B5
x16 |
| B4
x16 | B3
x10 |
| E1
Kr0 x4 | G5
#15 x16 |
| D10
3,5x13 x10 | G20
x8 |
| E2
H0 x4 | G7
x4 |
| EK2
6,3x13 x8 | S1
x10 |
| H6
L-246mm x2 | B3
x10 |
| D8
5x13 x4 | P1
x6 |
| LED2
x1 | UP9
3x16 x6 |
| L1
x1 | D11
3,5x25 x4 |
| KR2
x1 | UL
L-224 x3 |
| D22
4x40 x1 | I11
x4 |
| UP6
4x30 x6 | G2
S-4 x1 |

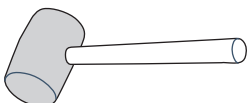
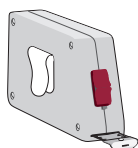
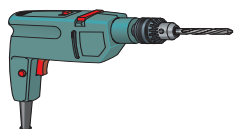
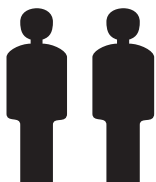
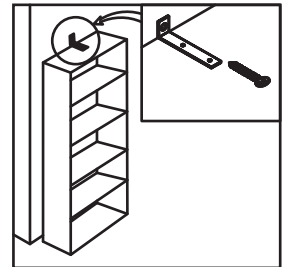
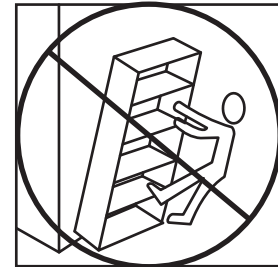
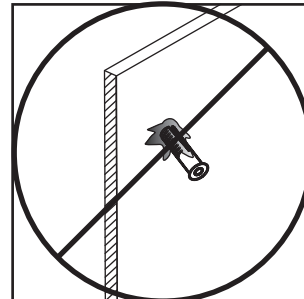
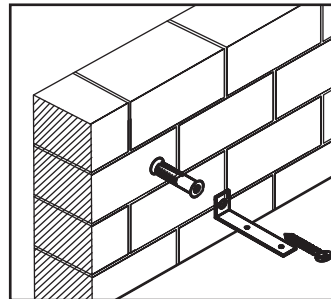
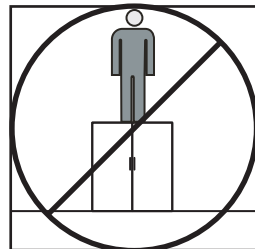
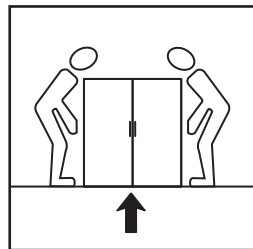
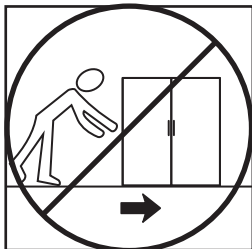
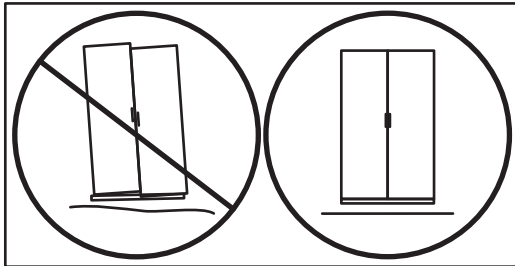
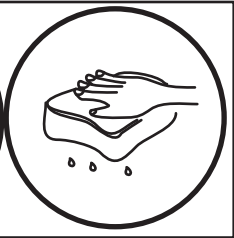
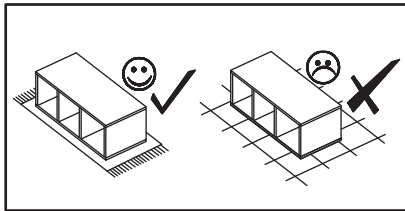
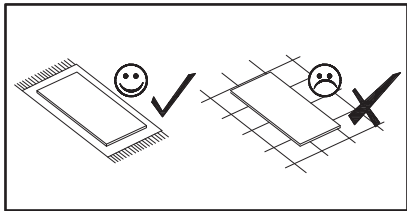
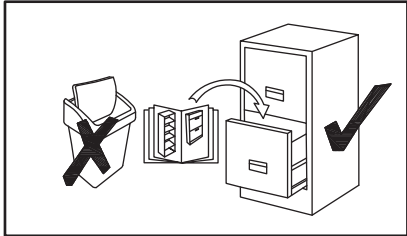
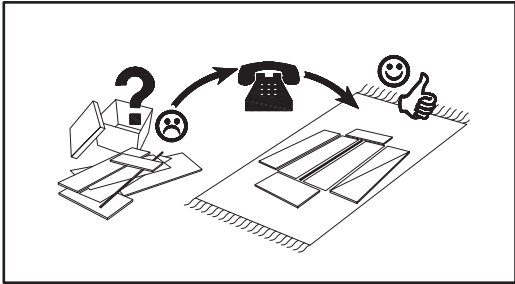

1

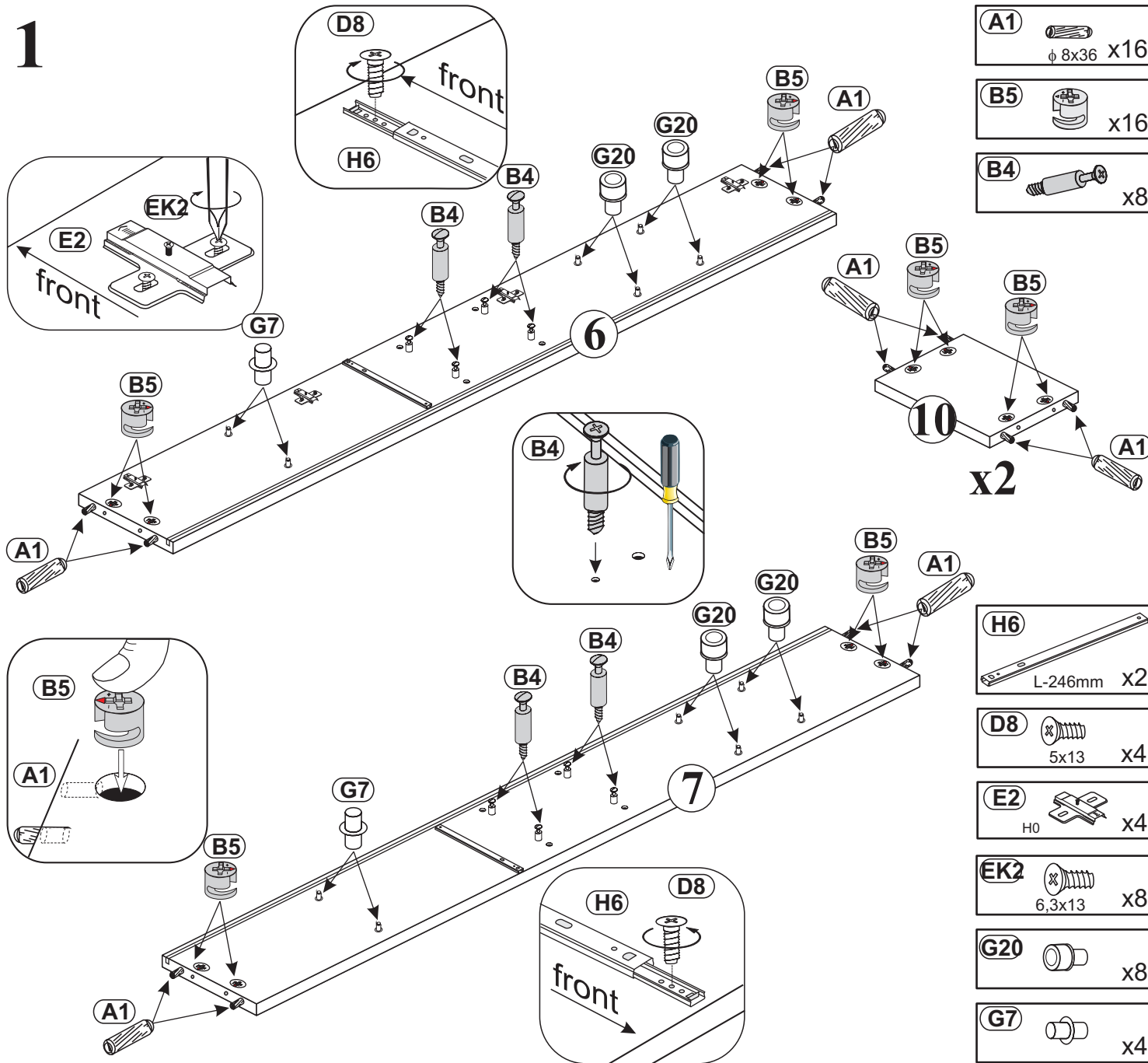

- A1** ϕ 8x36 x16
- B5** x16
- B4** x8
- H6** L-246mm x2
- D8** 5x13 x4
- E2** H0 x4
- EK2** 6,3x13 x8
- G20** x8
- G7** x4

2

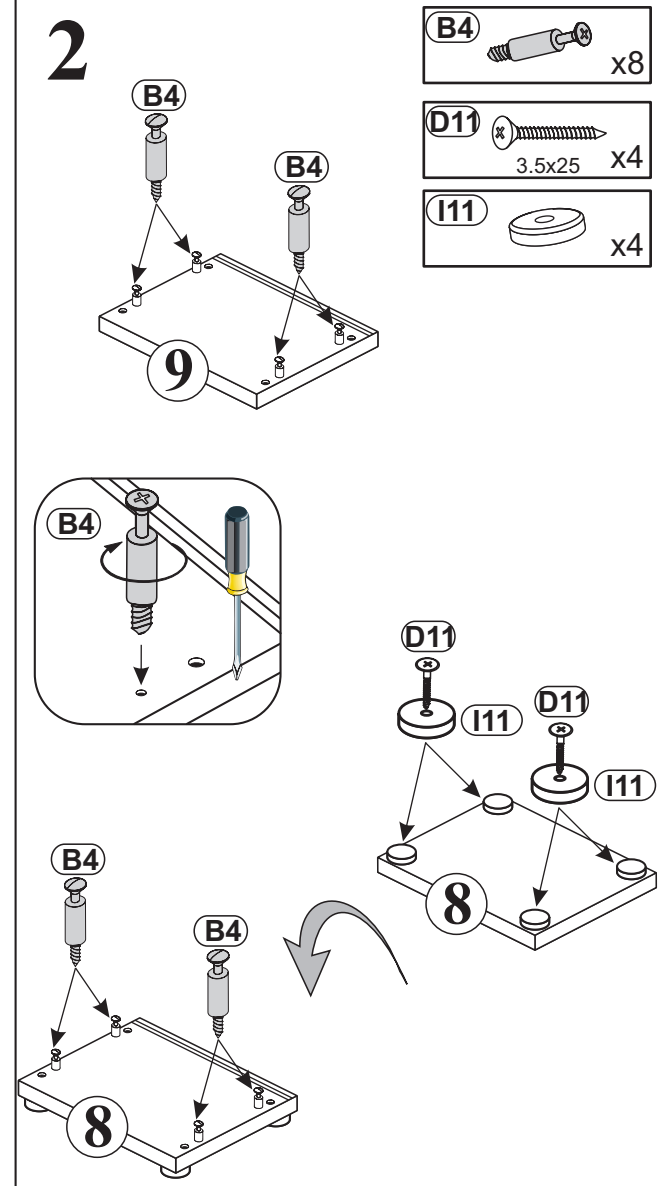

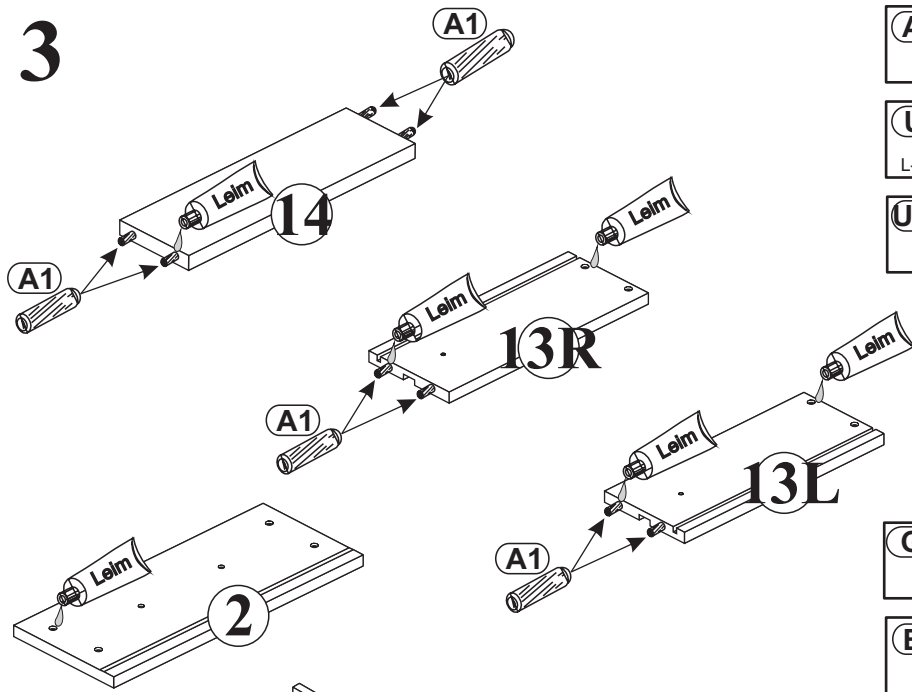

- B4** x8
- D11** 3.5x25 x4
- I11** x4

3



A1  ϕ 8x36 x8

UL  L-224 x1

UP6  4x30 x2

G1  Leim x1

B3  x4

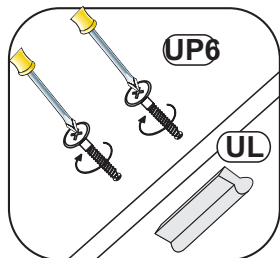
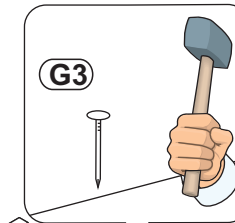
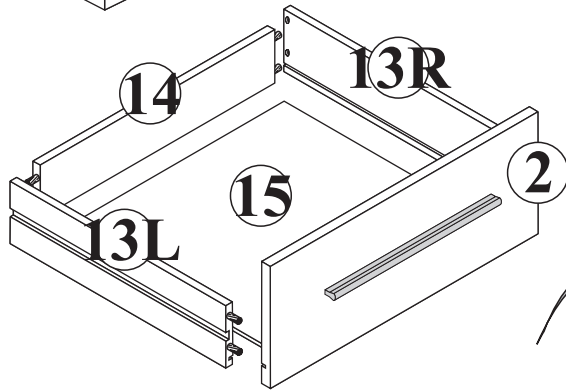

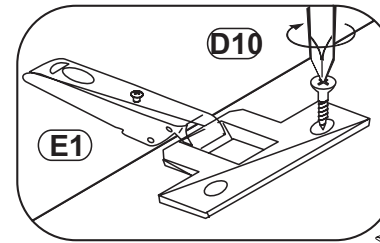

4





P1  x6

E1  Kr0 x4

UP9  3x16 x6

D10  3,5x13 x8

UL  L-224 x2

UP6  4x30 x4

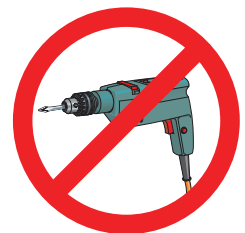
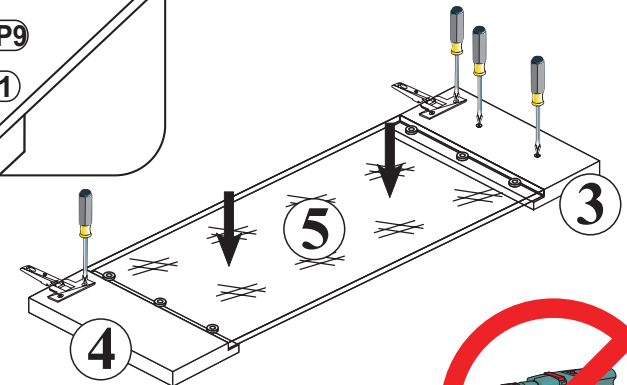
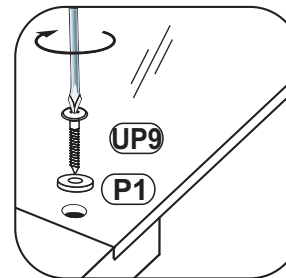
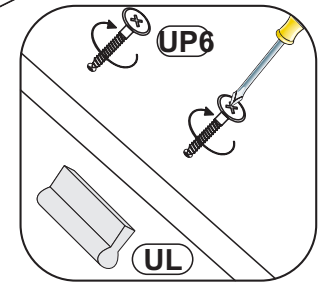
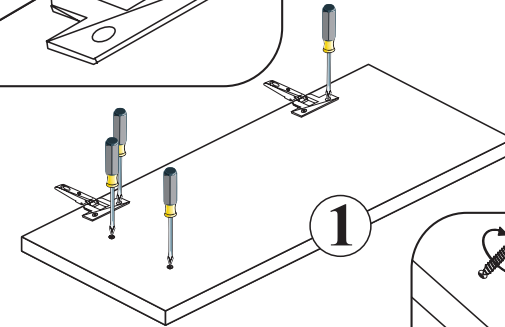

5

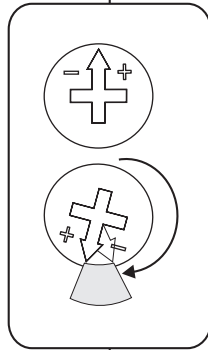
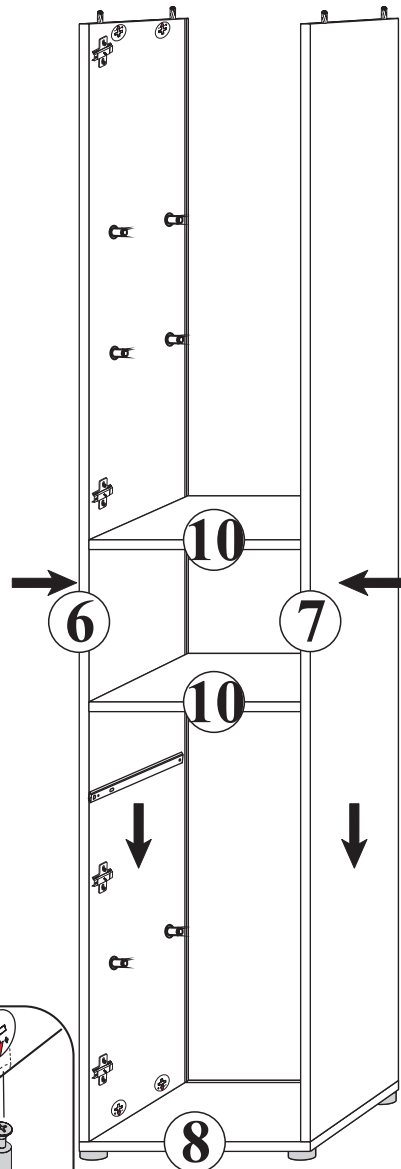

6

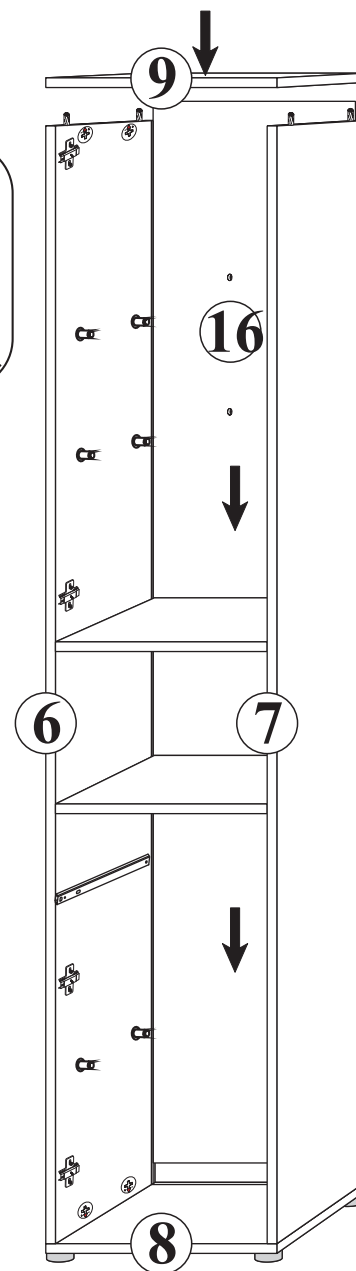
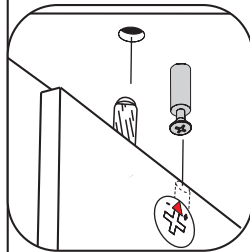

7

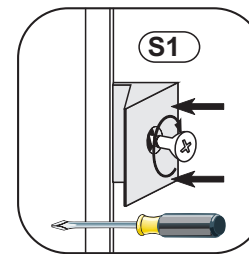
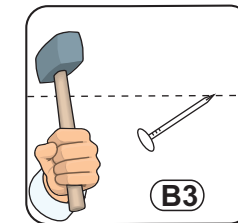
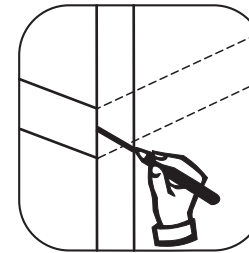
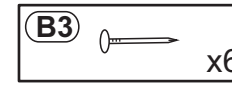
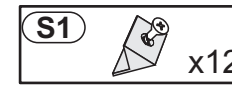

a=b

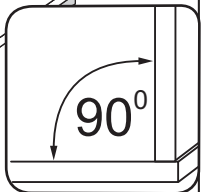
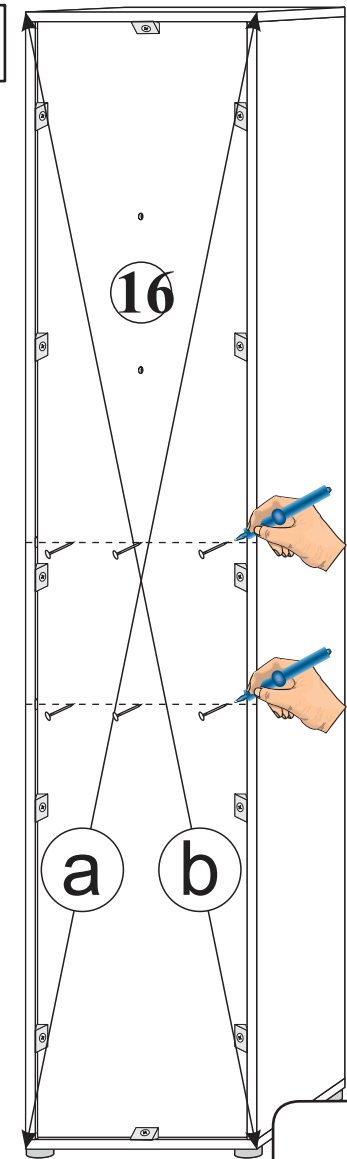

8

G5 #15 x16

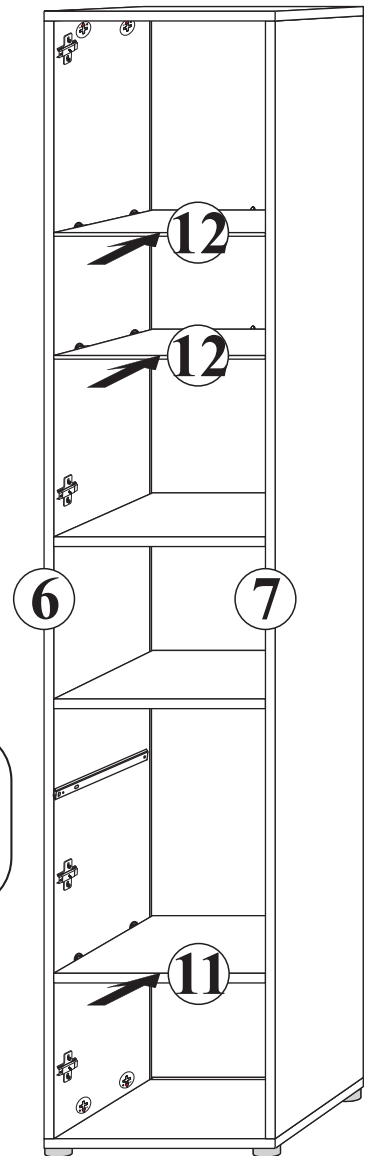
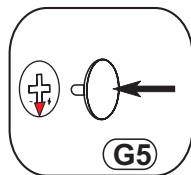

9

D18 M4x9mm x2

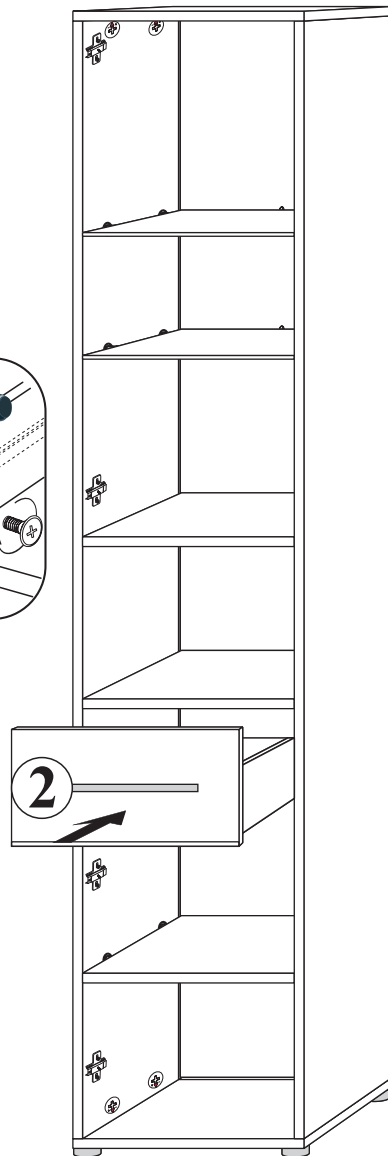
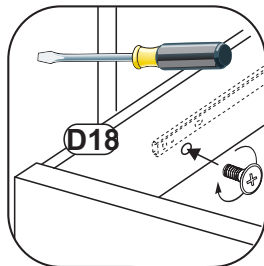

10

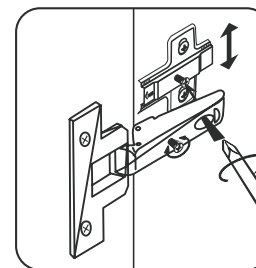

11

