

P185 / P208

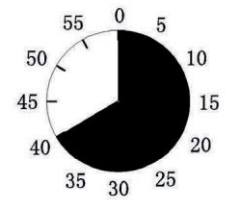

1

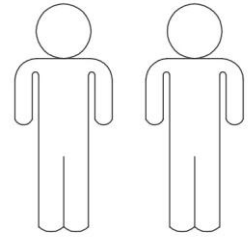
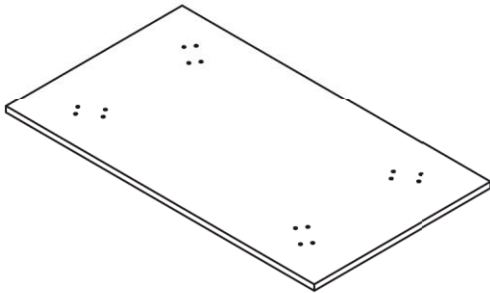

2.1



2.2

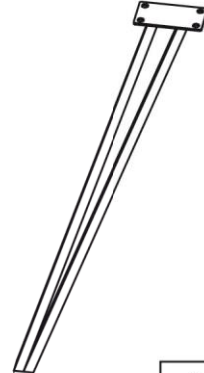



1	1x	1/2
2	4x	2/2

A	M8*12 16X	B	M8*16 16X	C	Ø18*Ø8*1.5 16X	D	Ø25 4X	E	5mm 1X
F	8mm 1X								

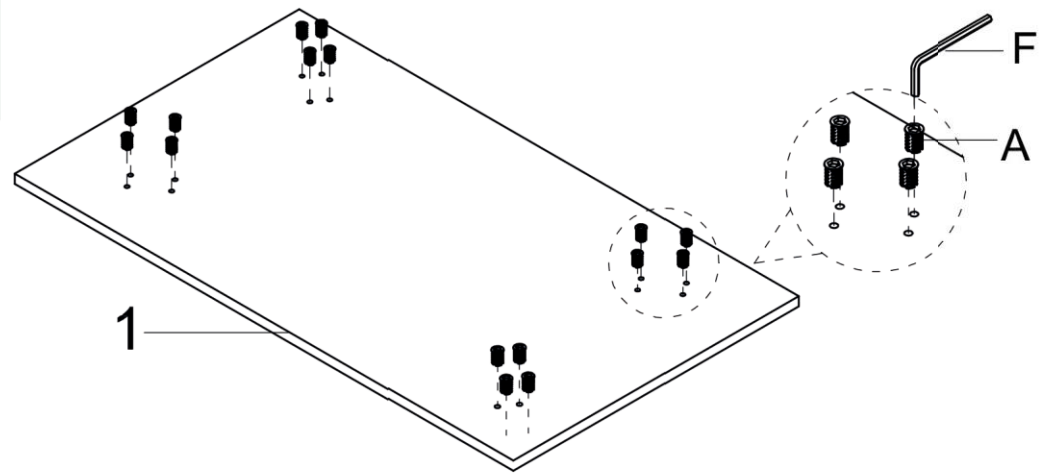



1.
1.

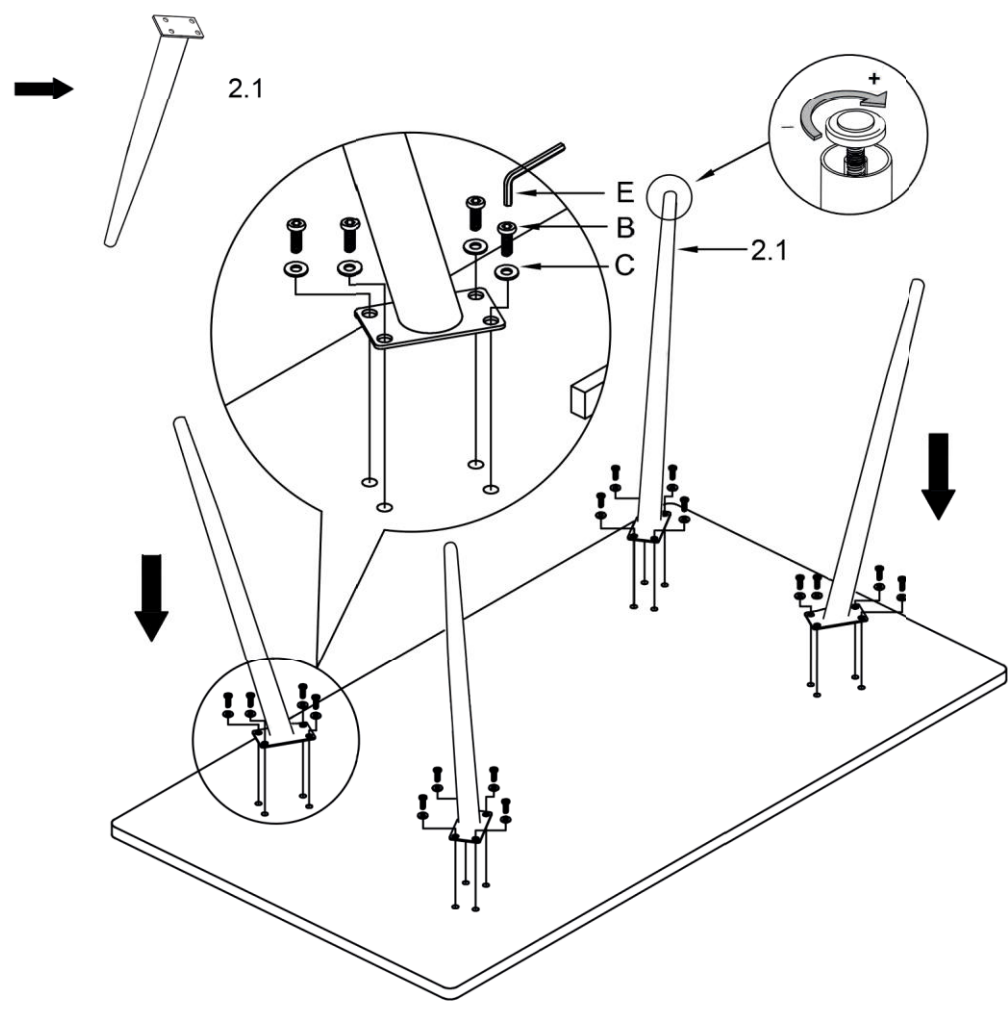

- A  M8*12
16X
- F  8mm
1X
-  100%

2.1



- B  M8*16
16X
- C  Ø18*Ø8*1.5
16X
- E  5mm
1X
-  100%

1.
2.2

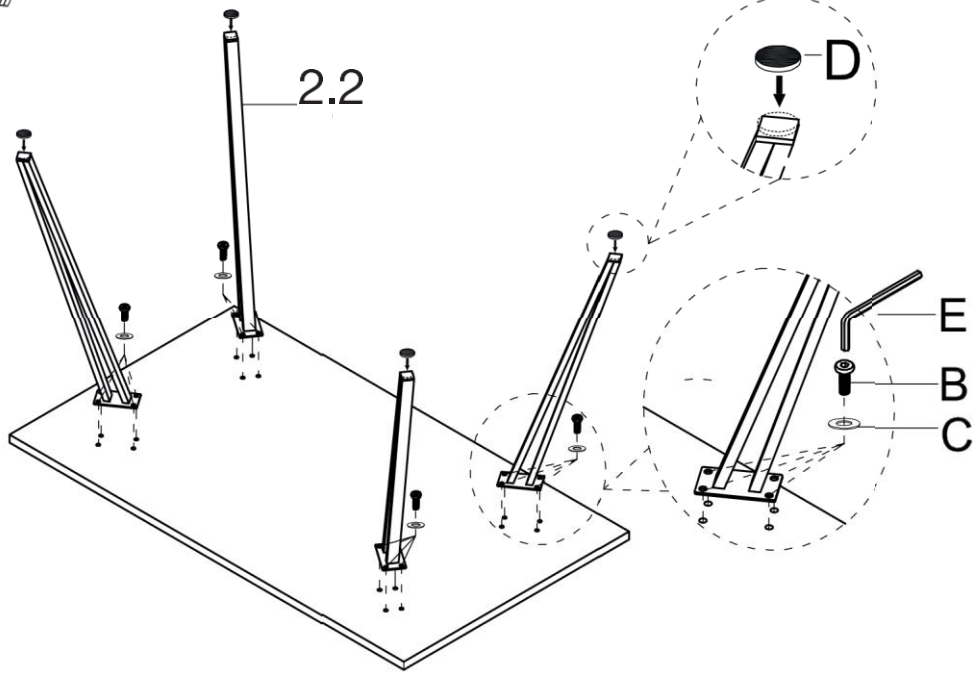
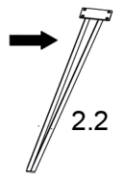

- B** M8*16
16X
 - C** Ø18*Ø8*1.5
16X
 - D** Ø25
4X
 - E** 5mm
1X
- 100%

3.

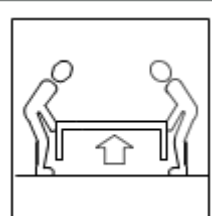
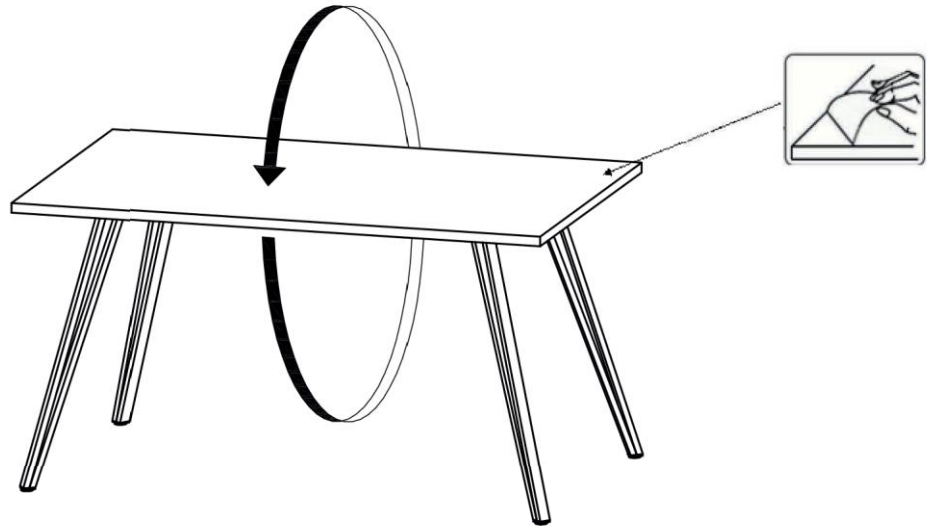
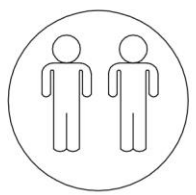

LE TRI + FACILE

Séparez les éléments avant de trier