

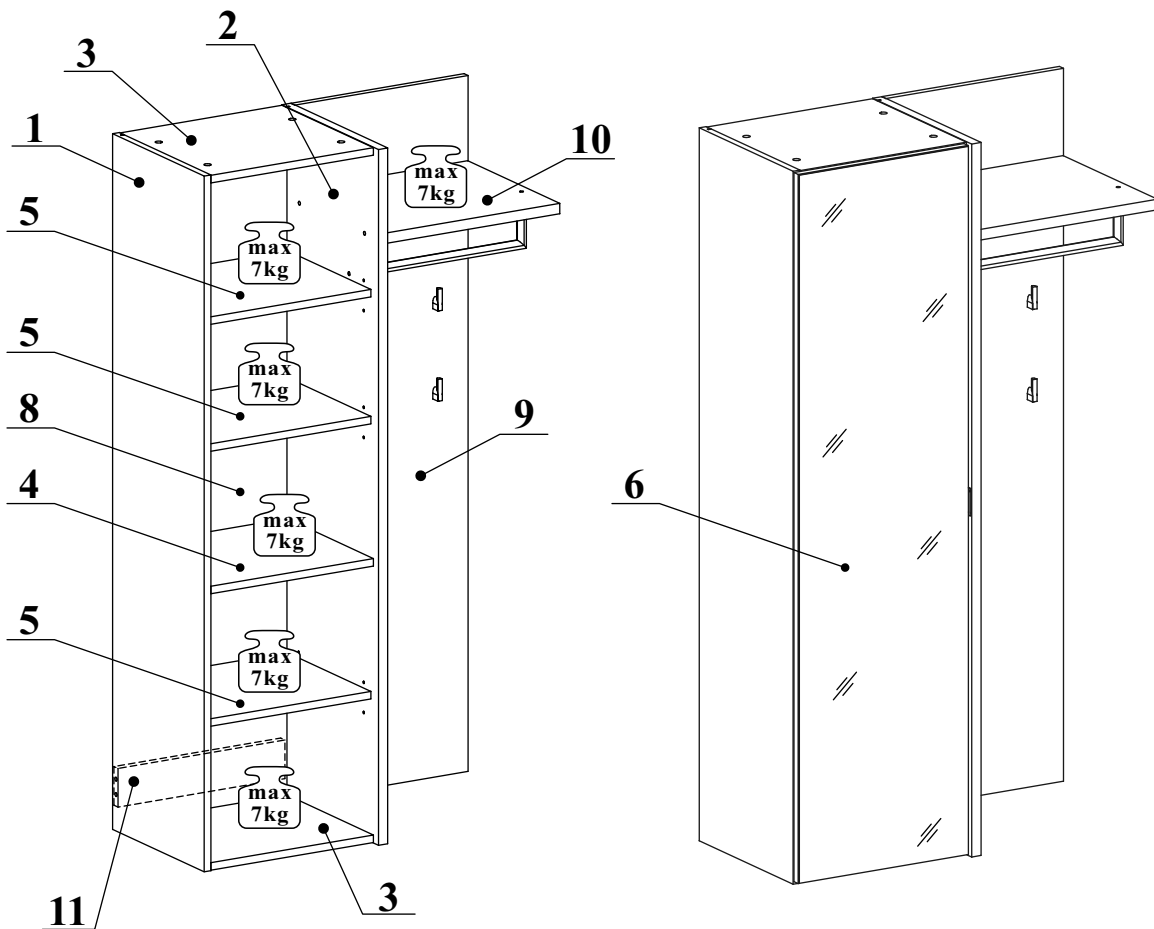

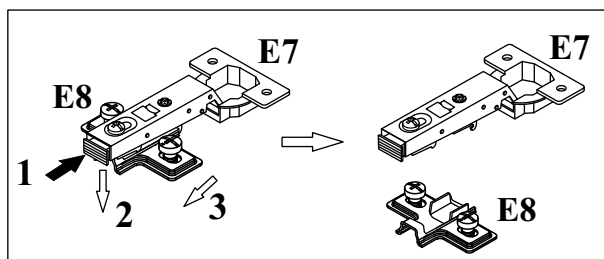

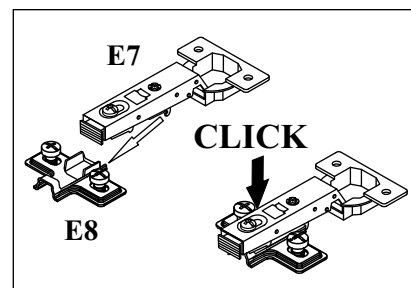

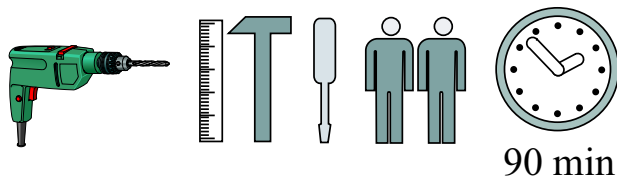



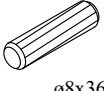
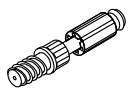

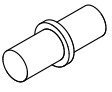
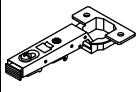

SINTRA 30 90 -- 42

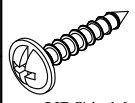
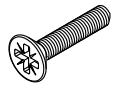

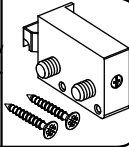
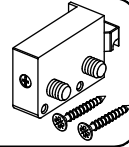
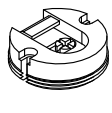
NO	Dim.		Col.-No	Qty
1	1480	360	1	1
2	1480	380	1	1
3	388	360	1	2
4	388	340	1	1
5	388	330	1	3
6	1472	396	2	1
8	1458	400	2	1
9	1480	414	2	1
10	412	362	1	1
11	388	80	1	1

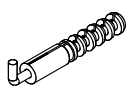
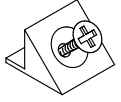

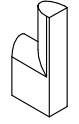
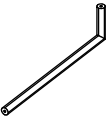
SINTRA 30 90 -- 42

A1 x18  ø8x36	B4 x12 	B5 x12  ø15x12	G5 x12 	G4 x4 	B11 x4  Ø7x50
G7 x12 	E7 x3 	E8 x3  H=0	U52 x1 	UP5 x2  UPØ4x16	WS3 x2  WSM4x30
D26 x8  M4x22	ZXL x1 	ZXP x1 	ZM1 x3 	D10 x6  USØ3,5x13	G2 x1 
KR2 x5 	S1 x8 	D20 x6  ESØ6x9,5	UP13 x3  UPØ3x16	WS1 x4 	WL x1 
KR1 x1  UPØ5x70					

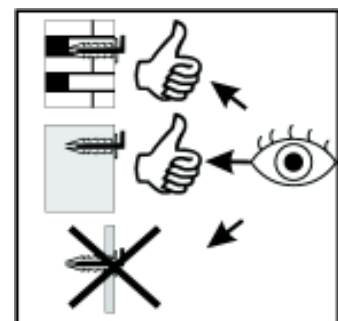
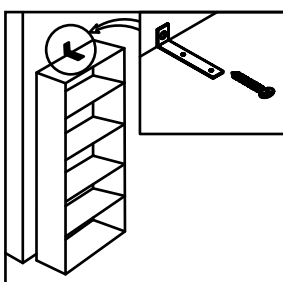
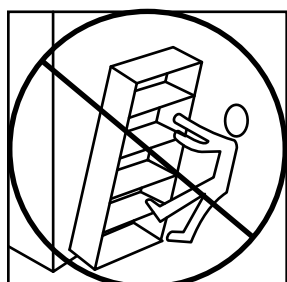
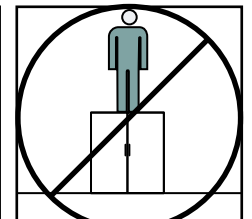
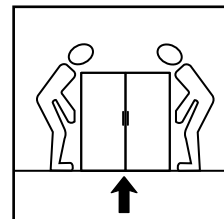
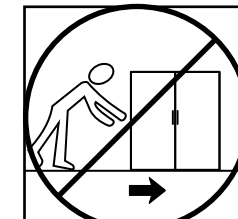
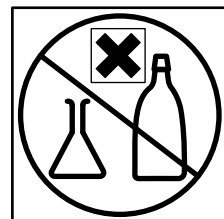
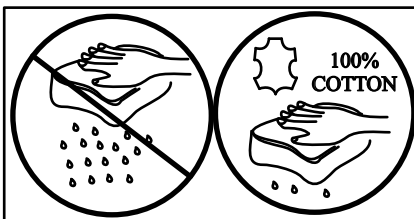
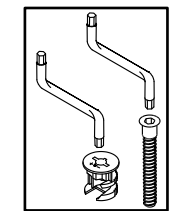
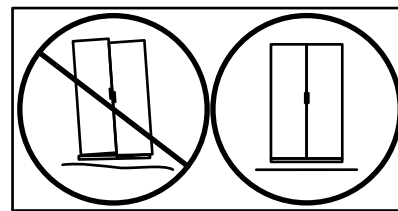
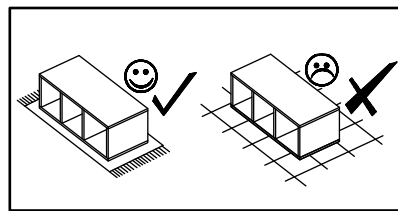
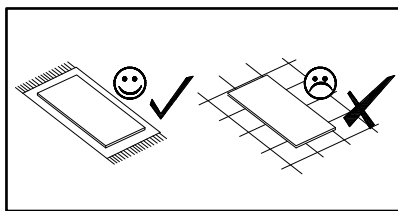
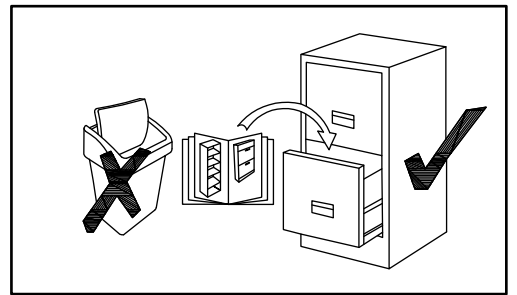
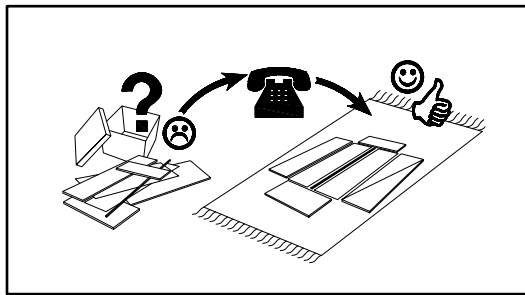
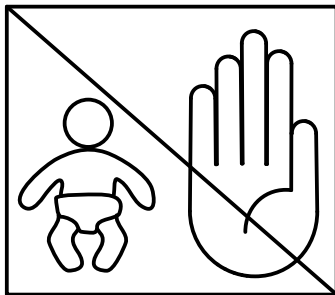
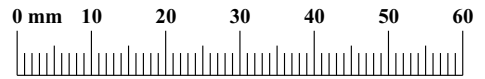

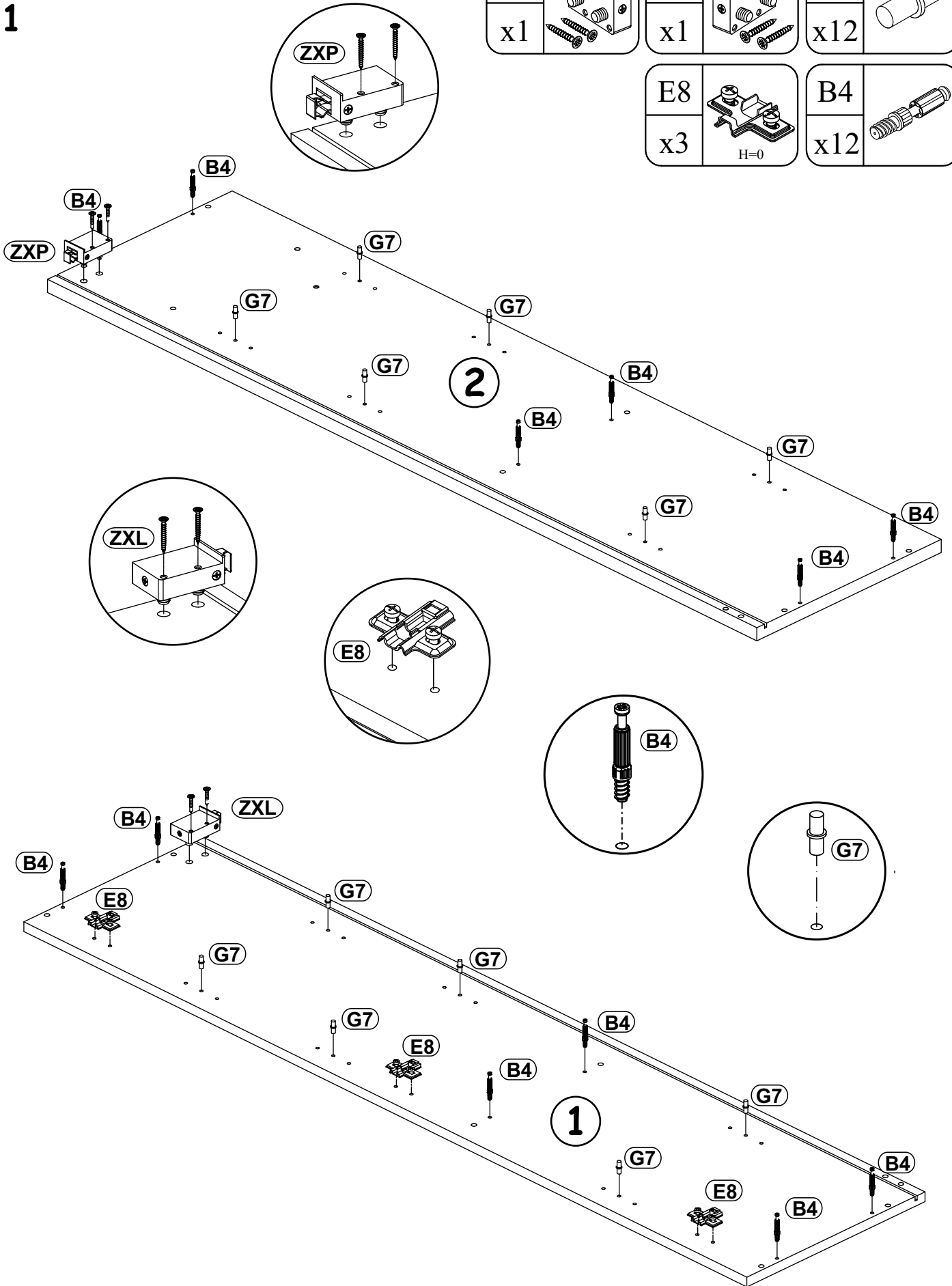

1

ZXL x1		ZXP x1		G7 x12	
E8 x3		B4 x12			

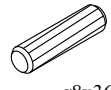

2

A1		B5	
x18	ø8x36	x12	ø15x12

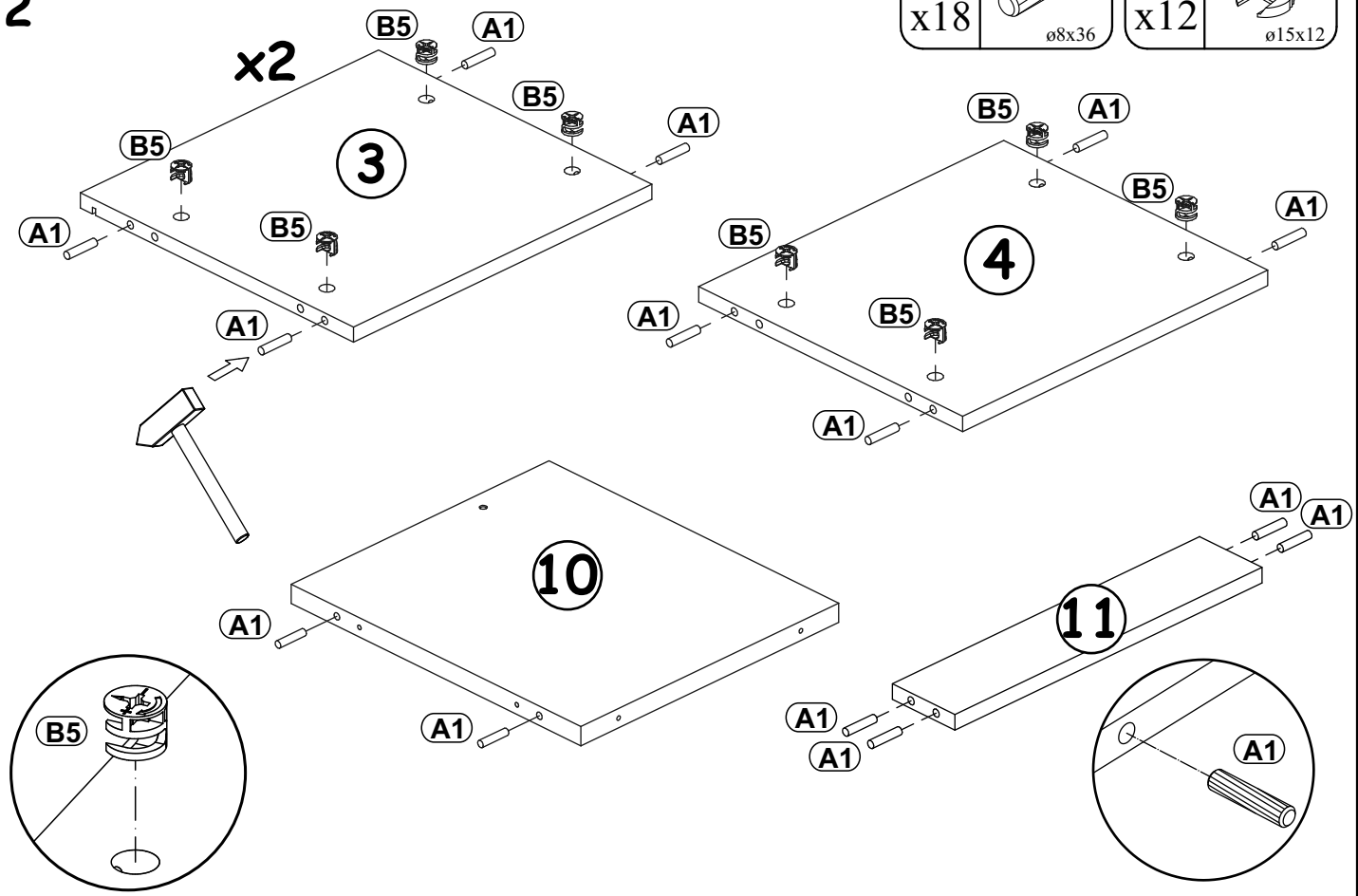

3

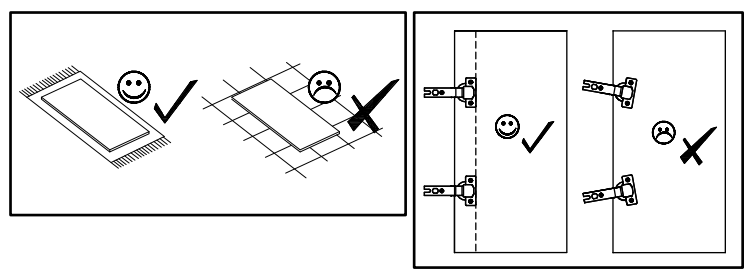

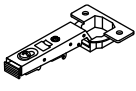
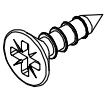
E7	
x3	
D10	
x6	USØ3,5x13

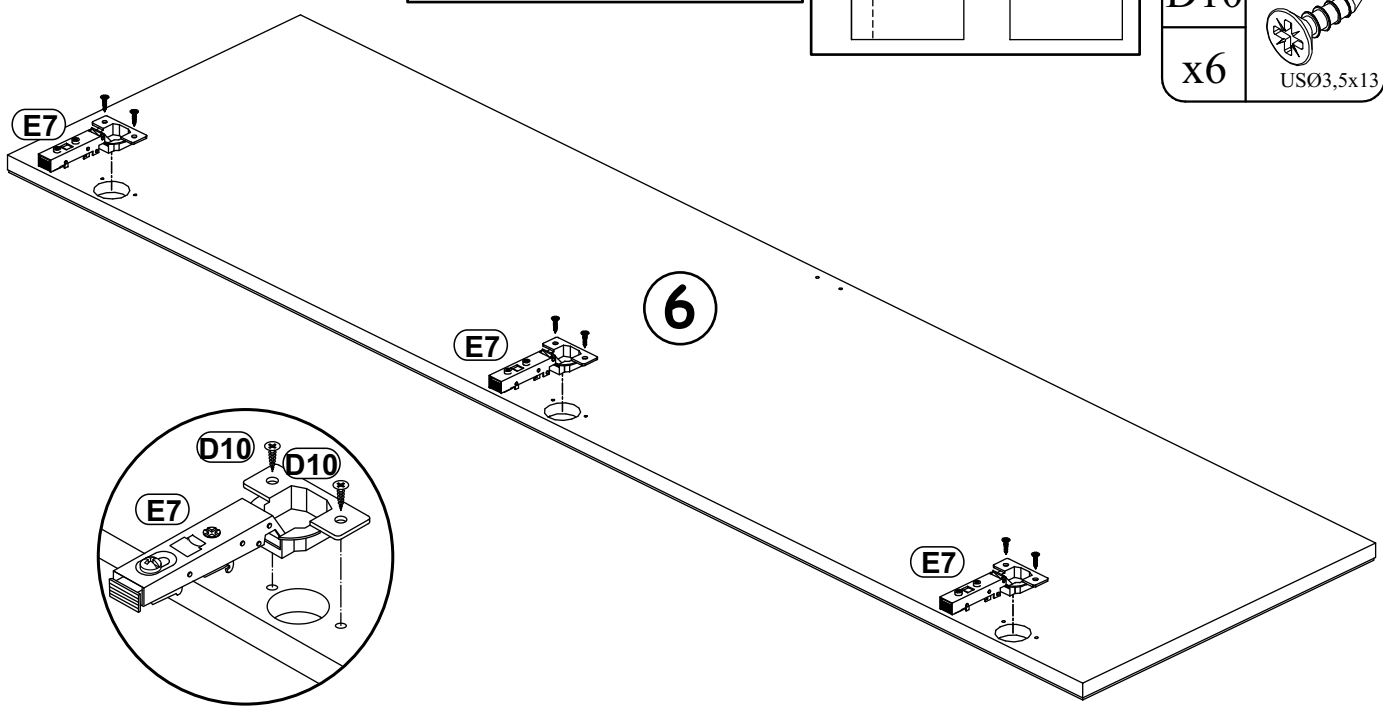

4

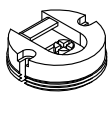
D20		ZM1	
x6	ESØ6x9,5	x3	

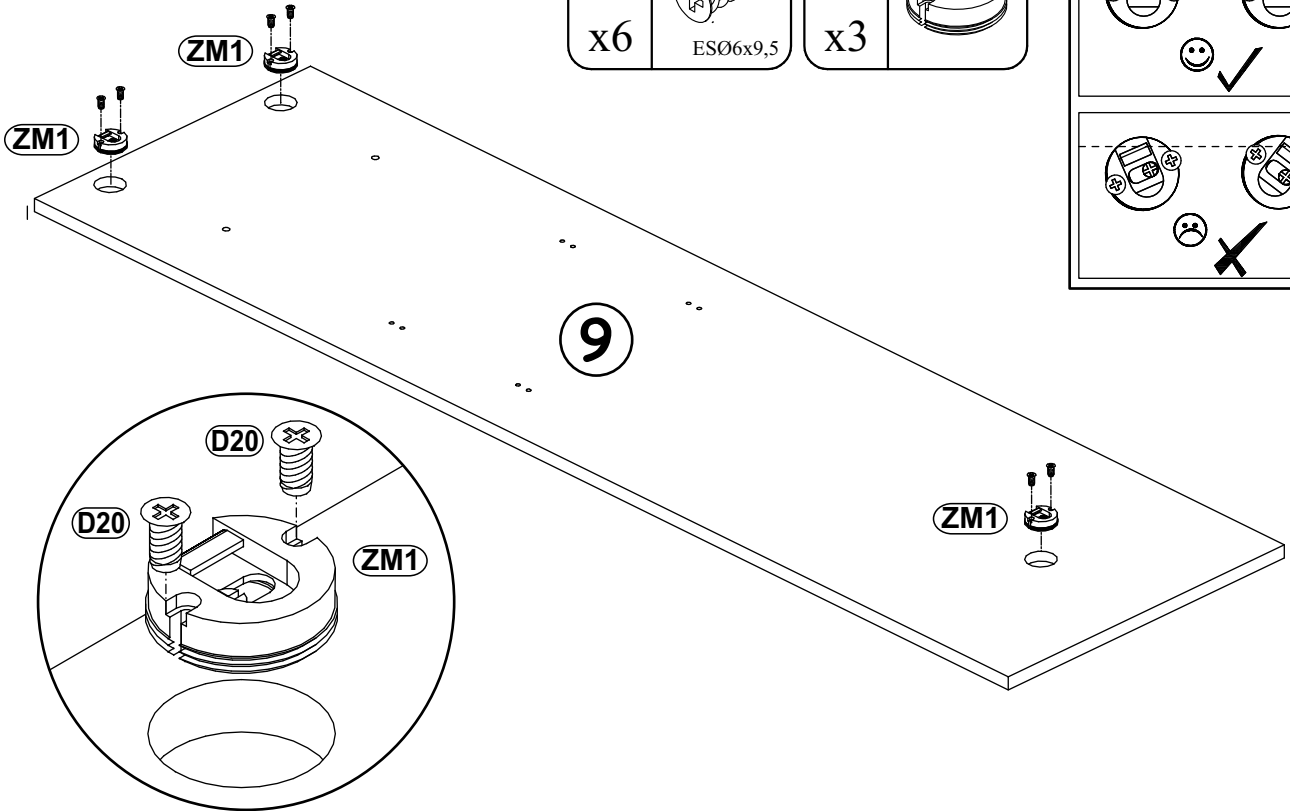
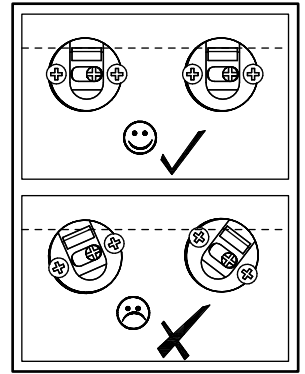

5

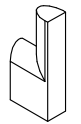
D26		WS1	
x8	M4x22	x4	

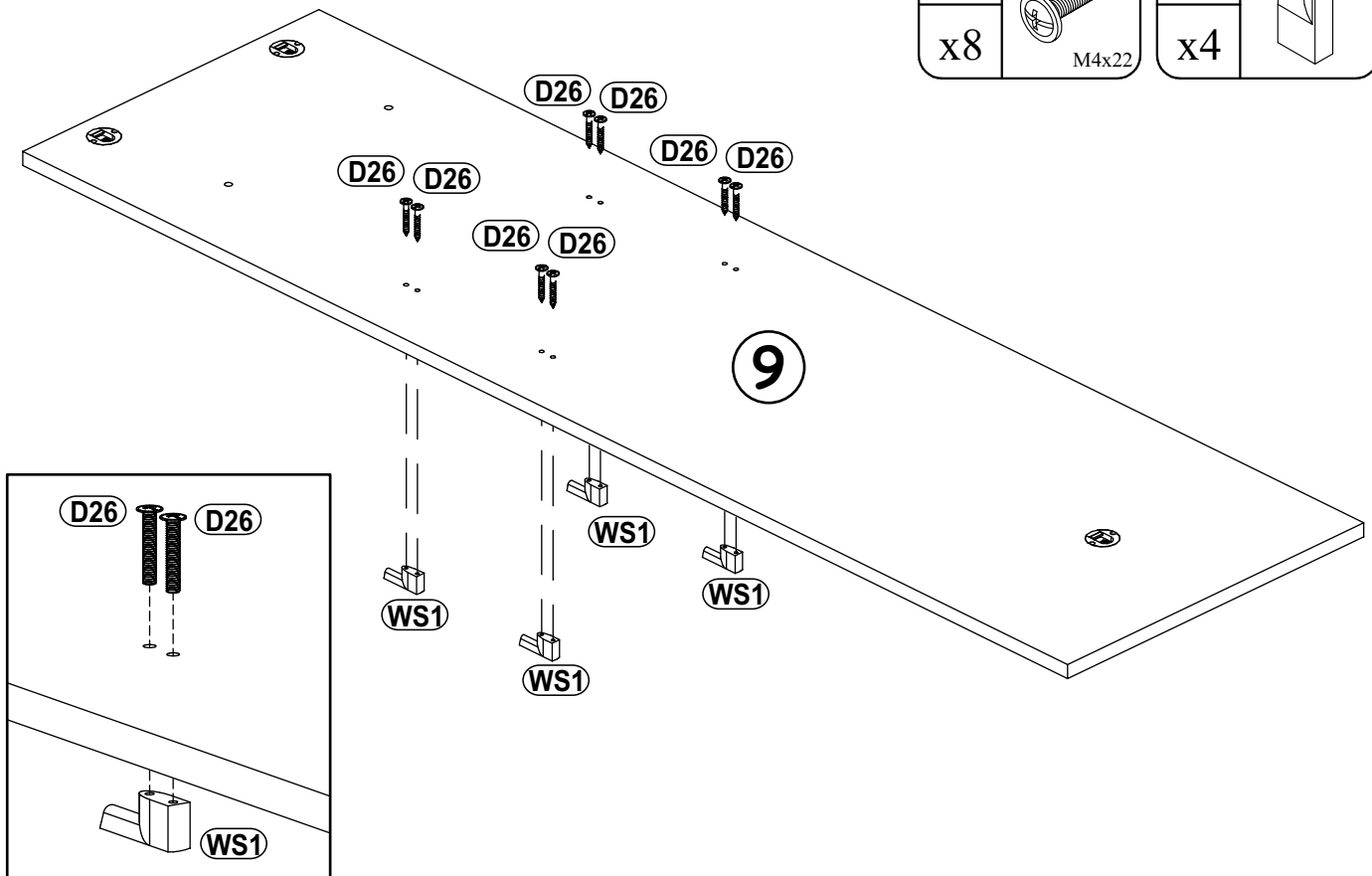

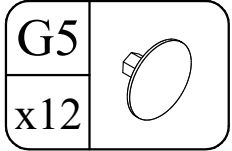

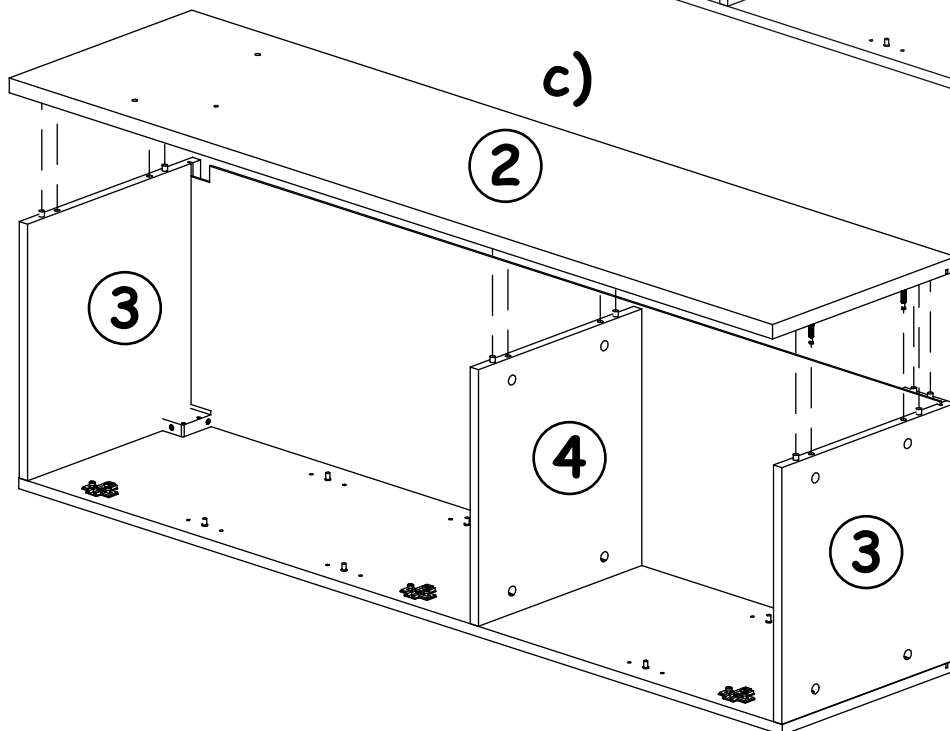
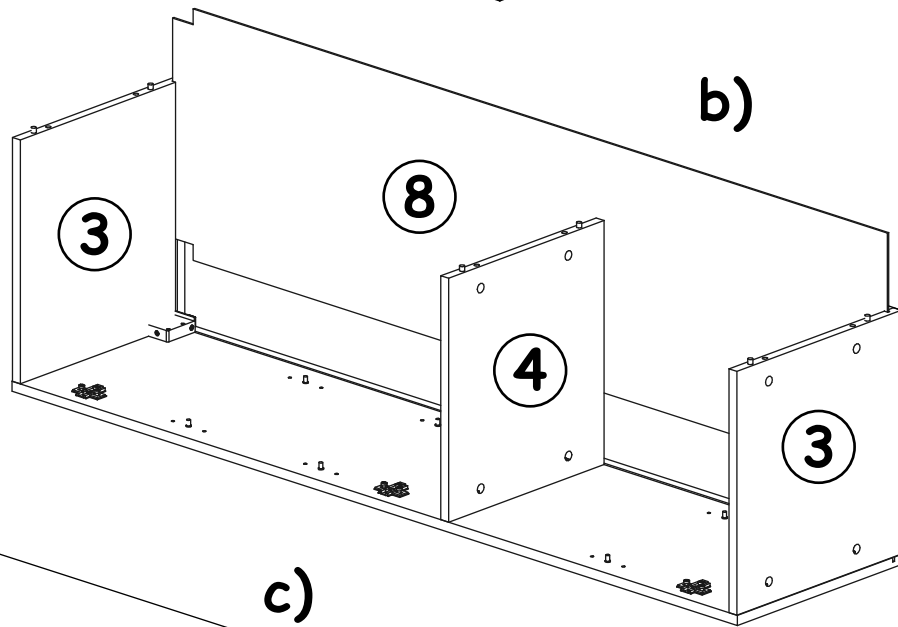
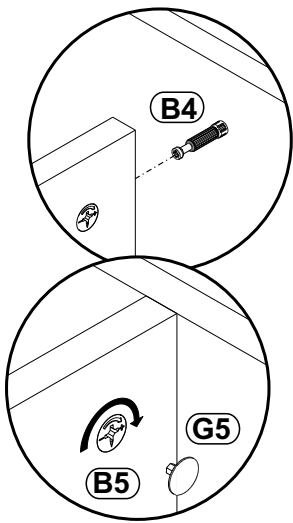
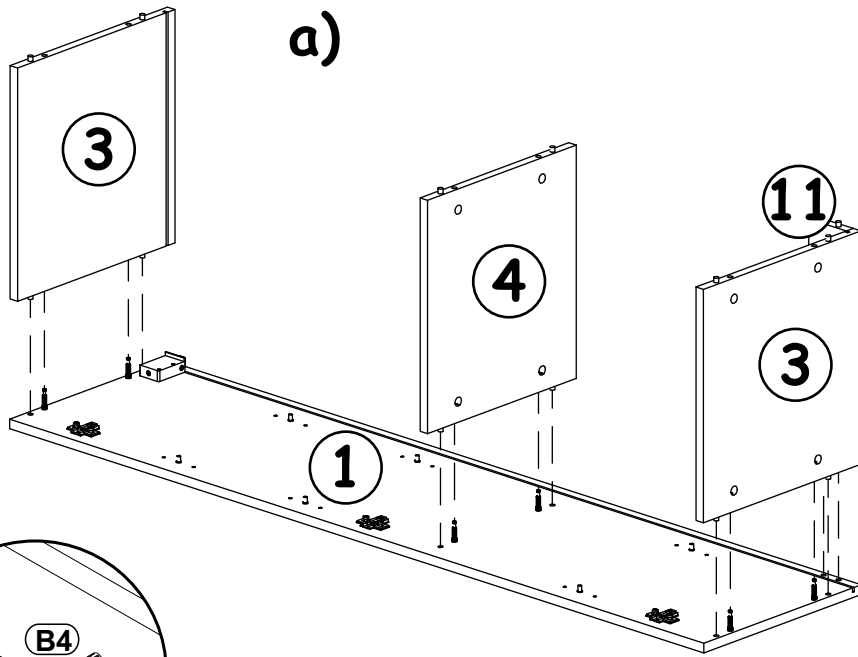

6

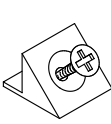

7

S1	
x8	

UP13	
x3	UPØ3x16

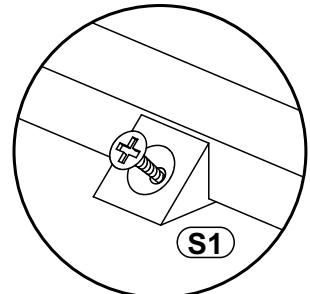
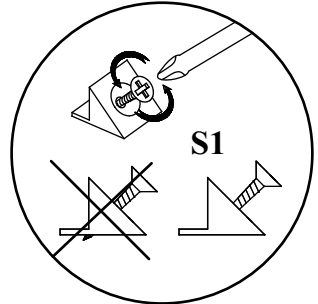
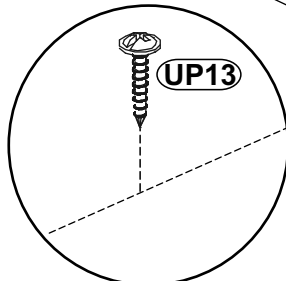
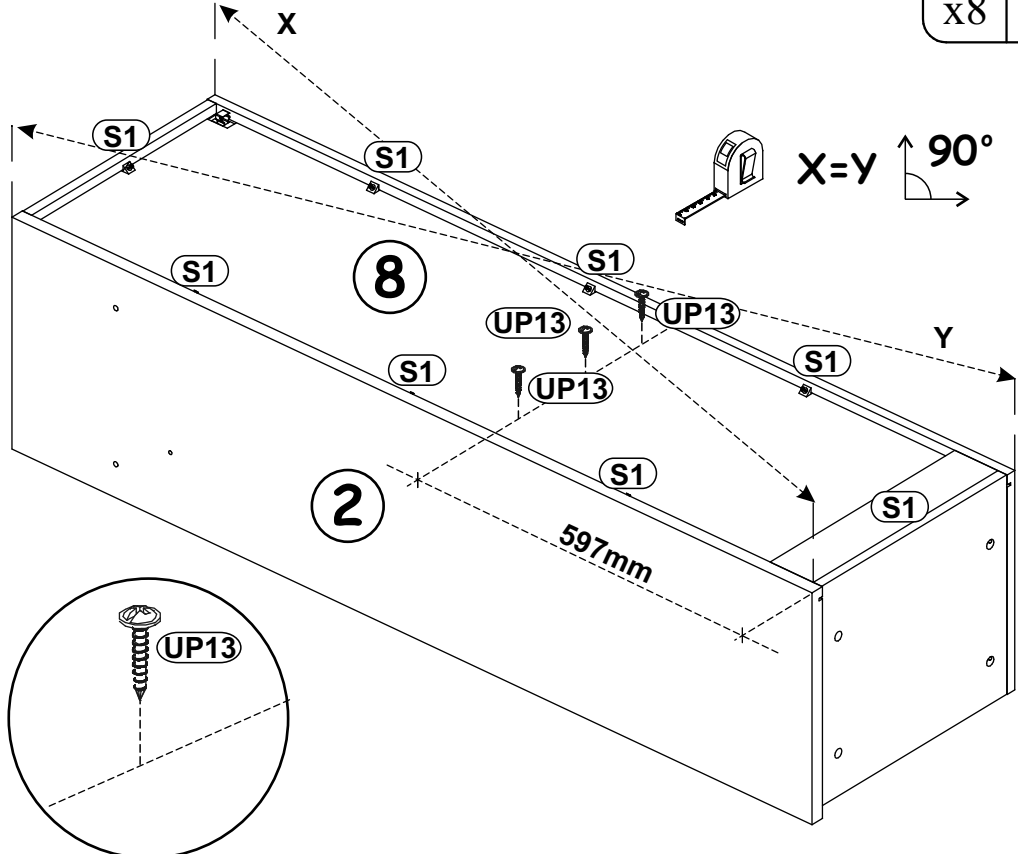

8

G4	
x2	

B11	
x2	Ø7x50

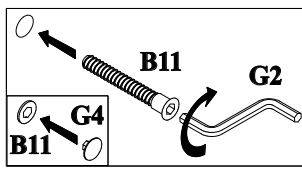
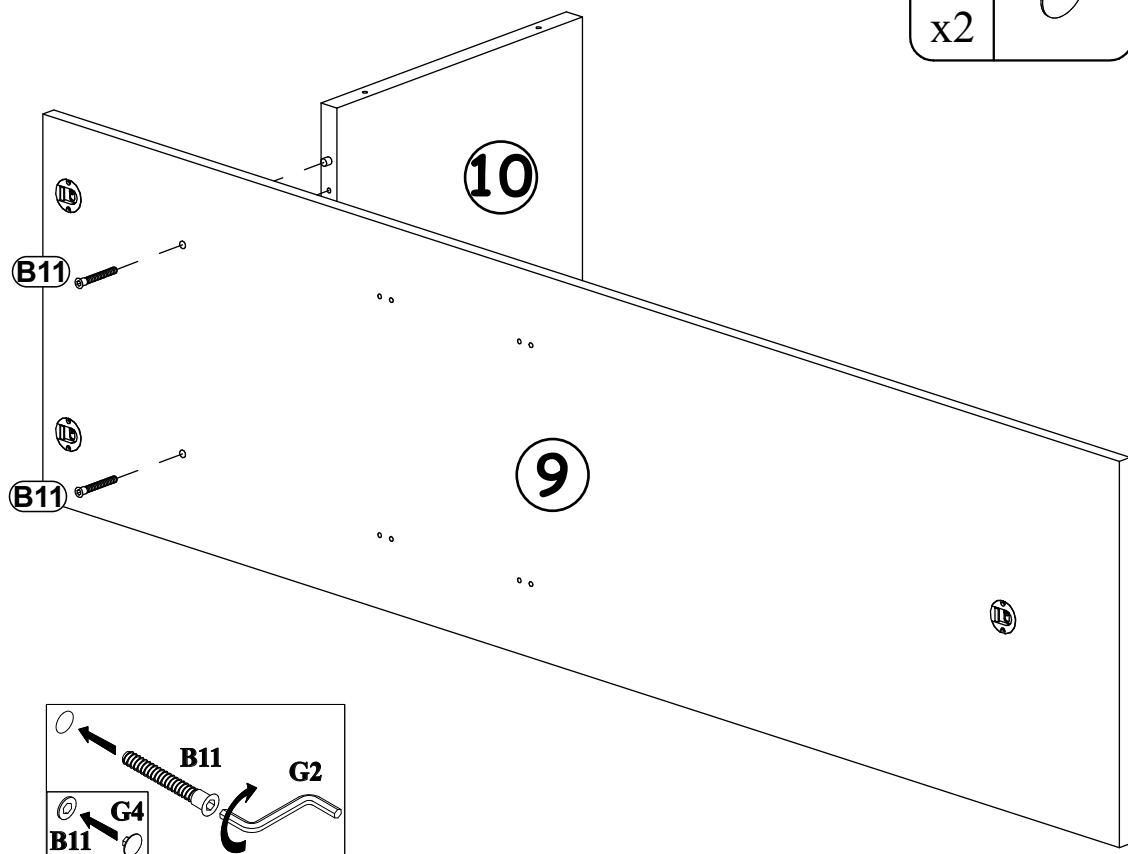

9

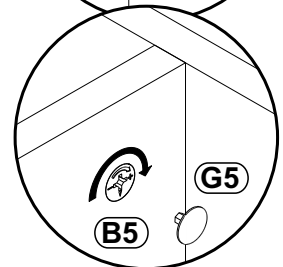
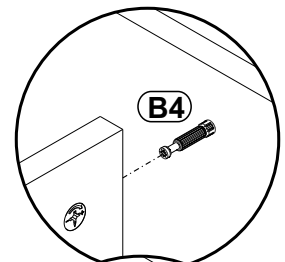
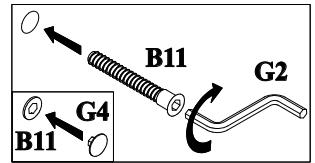
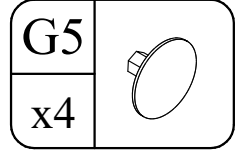
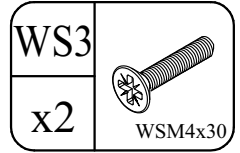
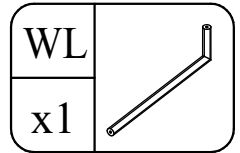
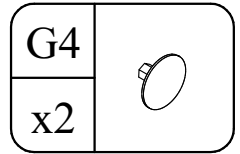
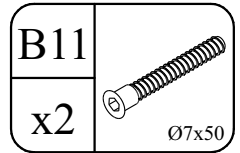
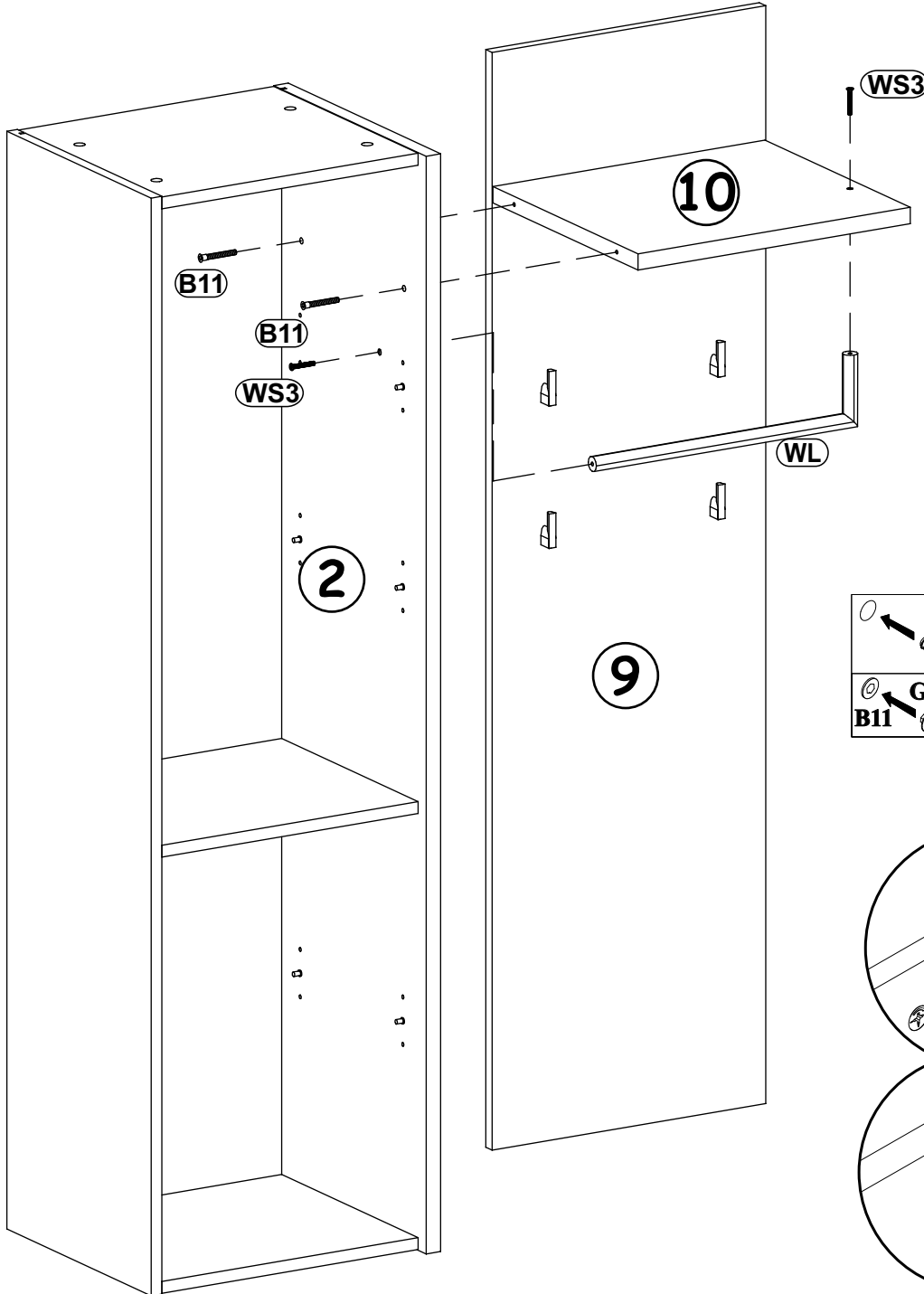

10

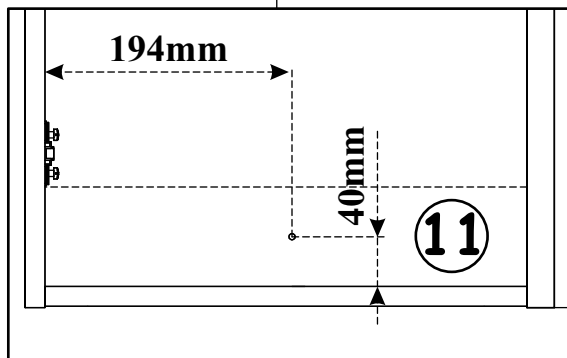
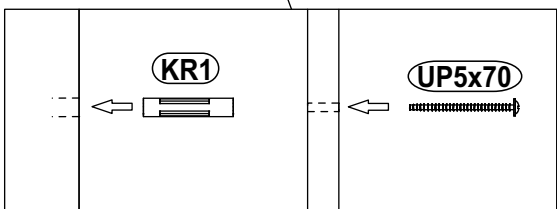
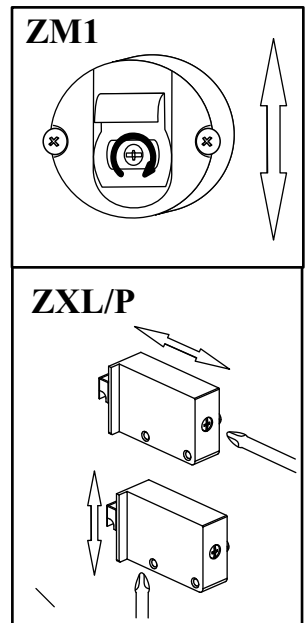
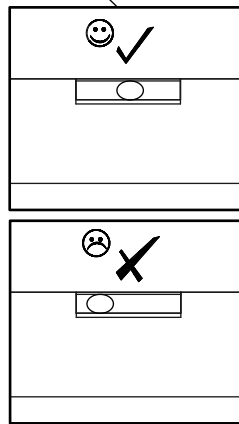
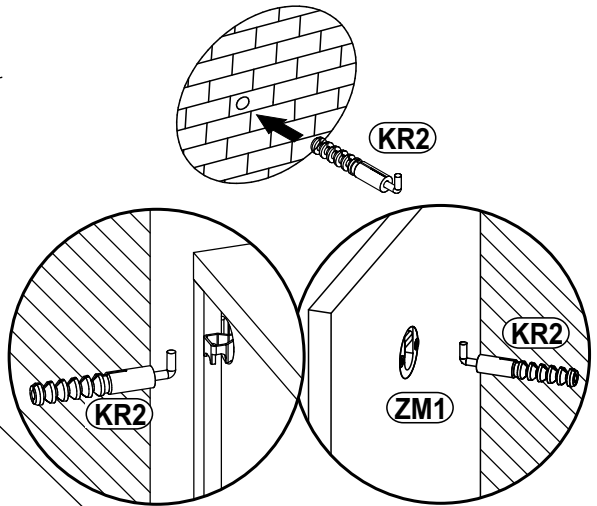
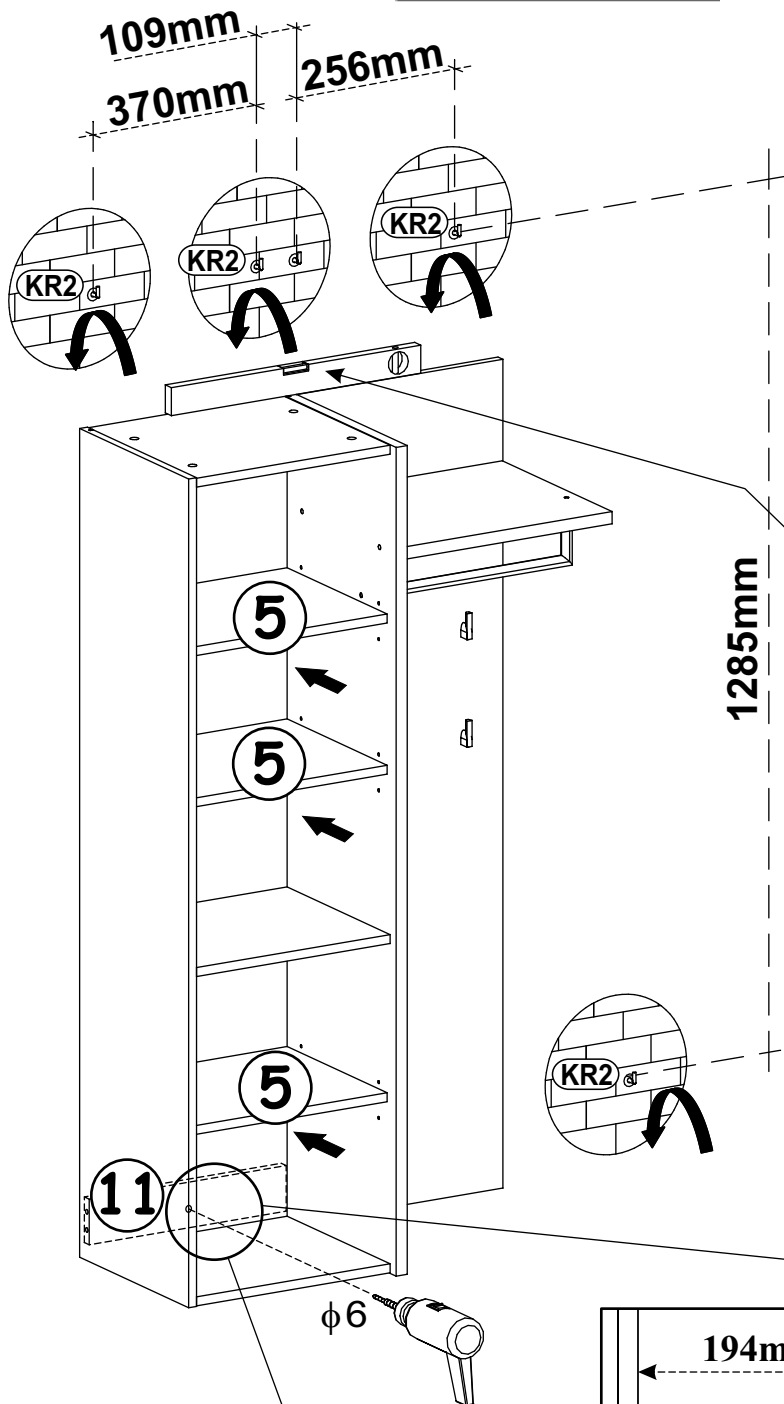
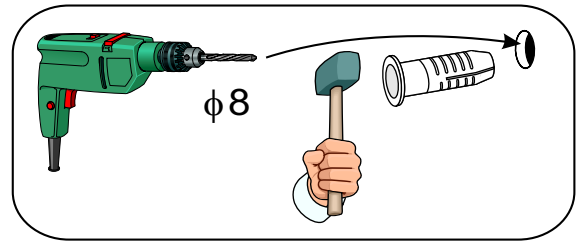
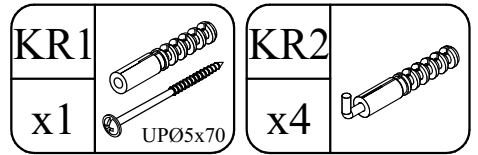
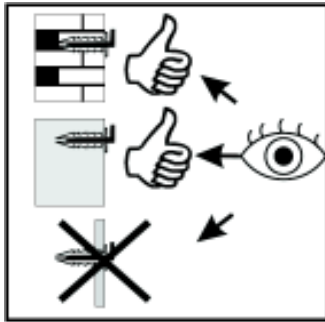

11

U52	
x1	

UP5	
x2	UPØ4x16

