

K23 2011 / 01

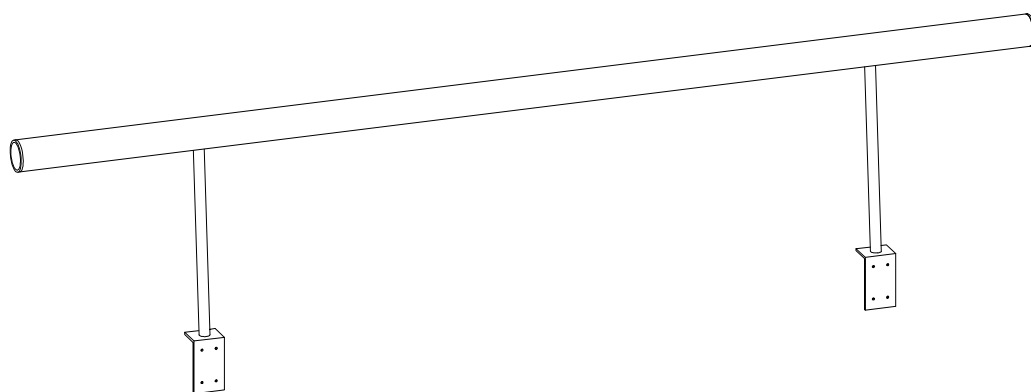

D Montageanleitung

GB Assembly instructions

NL Handleiding voor de montage

PL Instrukcja montażu

TR Montaj talimatı

RU Инструкция по монтажу

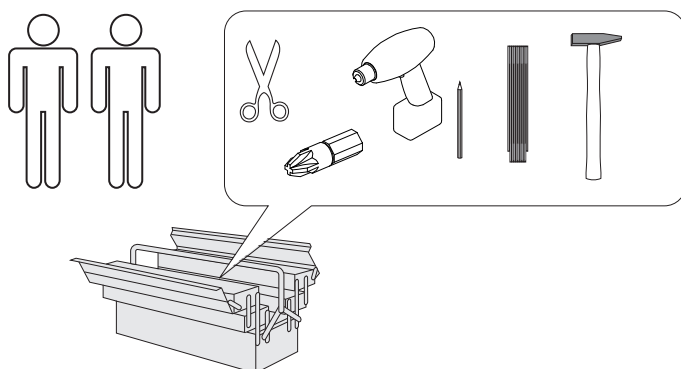

Service • Dienstverlening • Serwis • Servis • Сервисная служба

Name • Naam • Nazwa • İsim • Название

Nr. • No. • Номер



K23

Тур • Туре • Тір • Тип

K23 2011/01

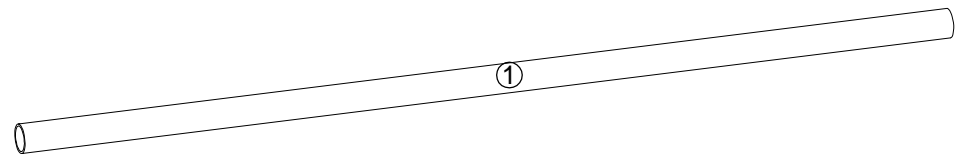
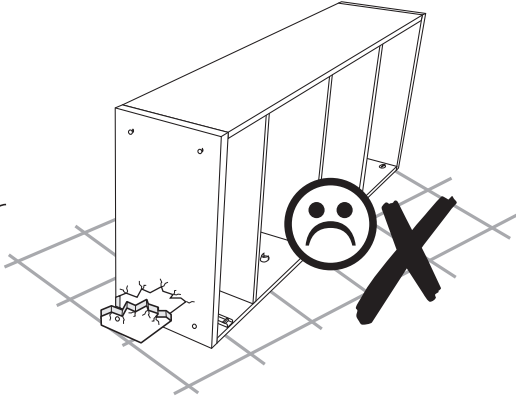
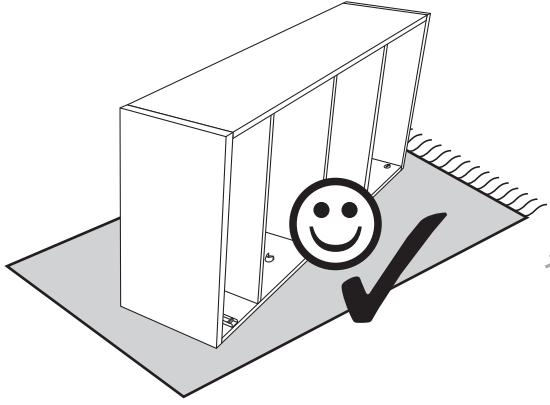
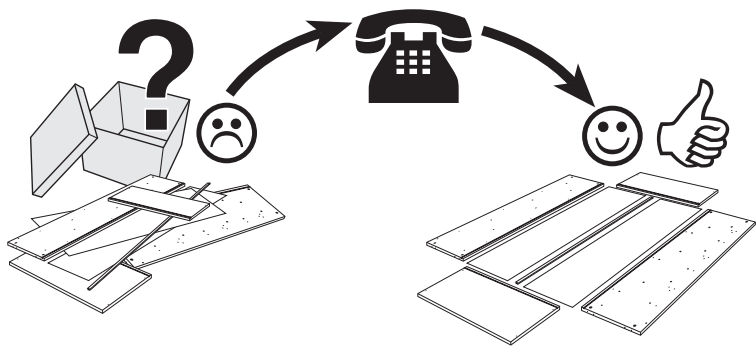
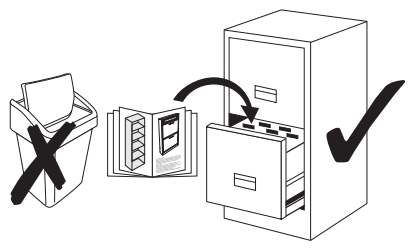

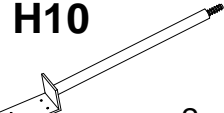
 **sist-grafik**

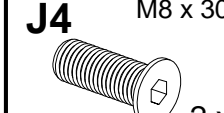
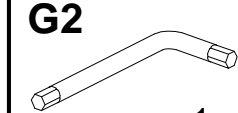

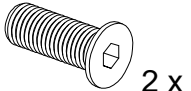

<p>H10</p>  <p>2 x</p>	<p>B1 3,5 x 20</p>  <p>8 x</p>	<p>L4</p>  <p>2 x</p>	<p>J4 M8 x 30</p>  <p>2 x</p>	<p>G2</p>  <p>1 x</p>
-----------------------------------------------------------------------------------------------------------------	--------------------------------------------------------------------------------------------------------------------------	-----------------------------------------------------------------------------------------------------------------	--------------------------------------------------------------------------------------------------------------------------	-------------------------------------------------------------------------------------------------------------------

0
10
20
30
40
50
60
70
80
90
100
110
120
130
140
150
160
170
180
190
200

A

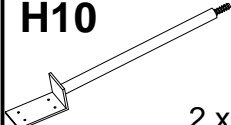
J4 M8 x 30  2 x	G2  1 x
------------------------------------------------------------------------------------------------------------------	-------------------------------------------------------------------------------------------------------

H10  2 x

L4  2 x

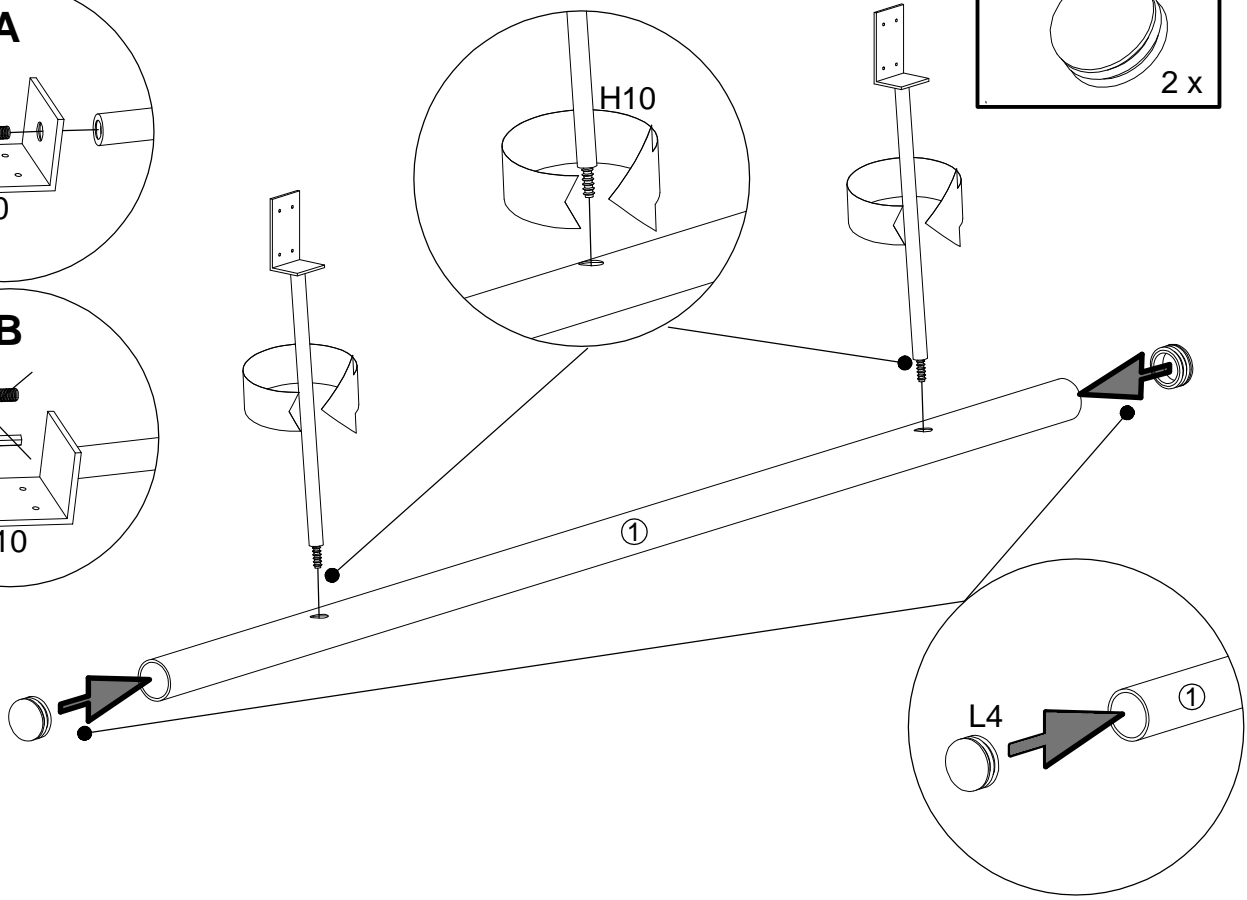
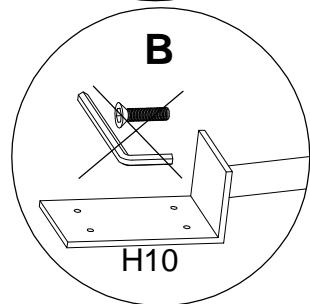
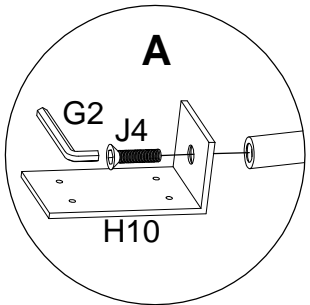

B

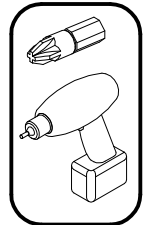
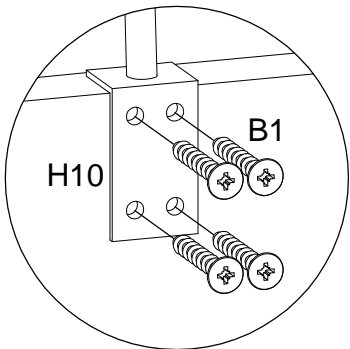

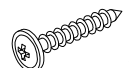
B1 3,5 x 20  8 x

