

## QUADRO 2 -4/4

### 35-362-...

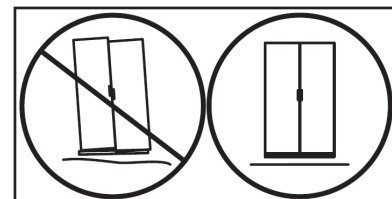

**x4**

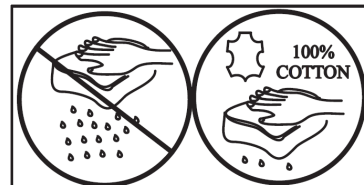
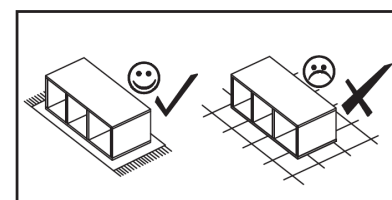
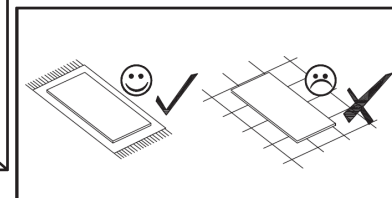
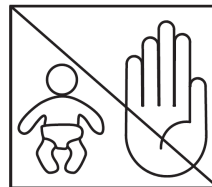
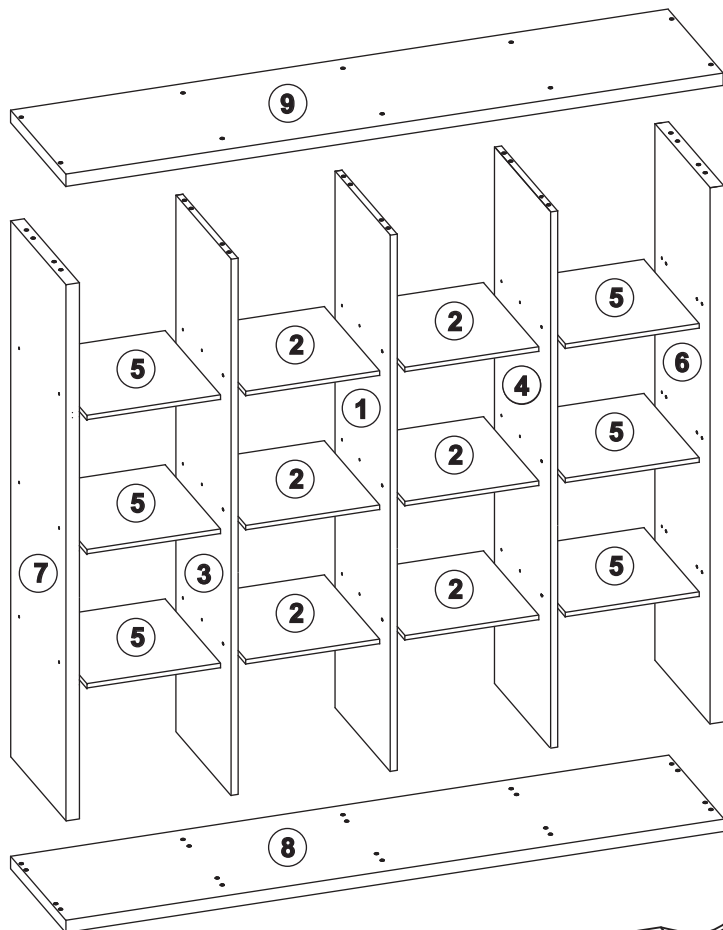
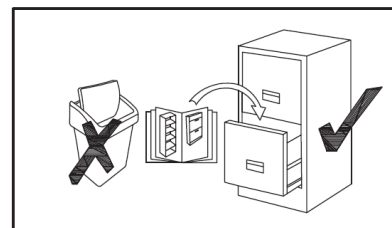
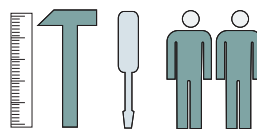
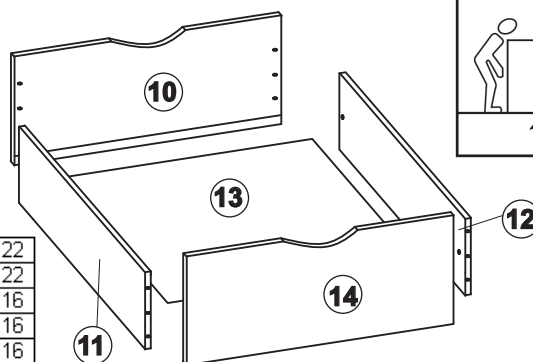

1/2	EL-QUA-2-DACH-D-DB	8	x1	1452	330	22
	EL-QUA-2-DACH-G-DB	9	x1	1452	330	22
	EL-QUA-2-WIENIEC-L/P-BI	5	x6	340	328	16
	EL-QUA-2-WIENIEC-S-BI	2	x6	340	328	16
	EL-QUA-BOCZ-SZ-L-BI	11	x4	290	240	16
	EL-QUA-BOCZ-SZ-P-BI	12	x4	290	240	16

2/2	EL-QUA-2-BOK-L-DB	7	x1	329	1409	22
	EL-QUA-2-BOK-P-DB	6	x1	329	1409	22
	EL-QUA-2-PRZEG-L-BI	3	x1	329	1409	16
	EL-QUA-2-PRZEG-P-BI	4	x1	329	1409	16
	EL-QUA-2-PRZEG-S-BI	1	x1	329	1409	16
	EL-QUA-DNO-SZUFL-HDF-BI	13	x4	305	315	3
	EL-QUA-FRO-BI	10	x4	335	335	16
	EL-QUA-FRO-DB	14	x4	335	335	16

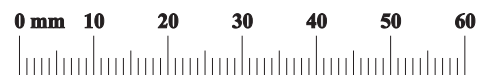





E1 x16	E2 x34	E3 x34	E5 x9	H1 x32	H3 x22	W6 x1
L1 x1	W4 x2	W5 x1	W7 x6	K1 x64	K2 x18	O1 x1

# QUADRO 2 -4/4

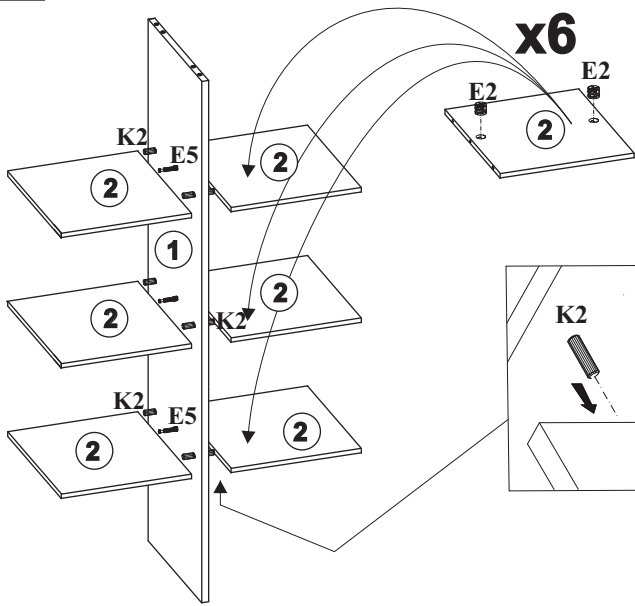
2/4

01

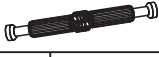

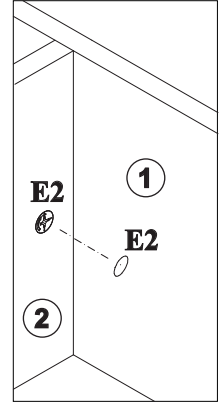
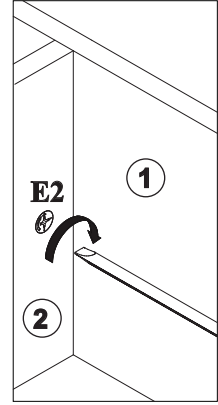
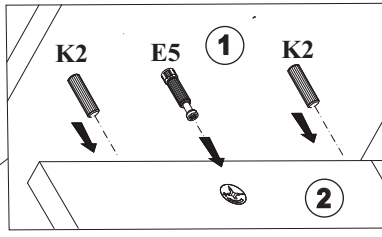

	15x12,5		
E2	x6	E3	x6
			
E5	x3	K2	x6

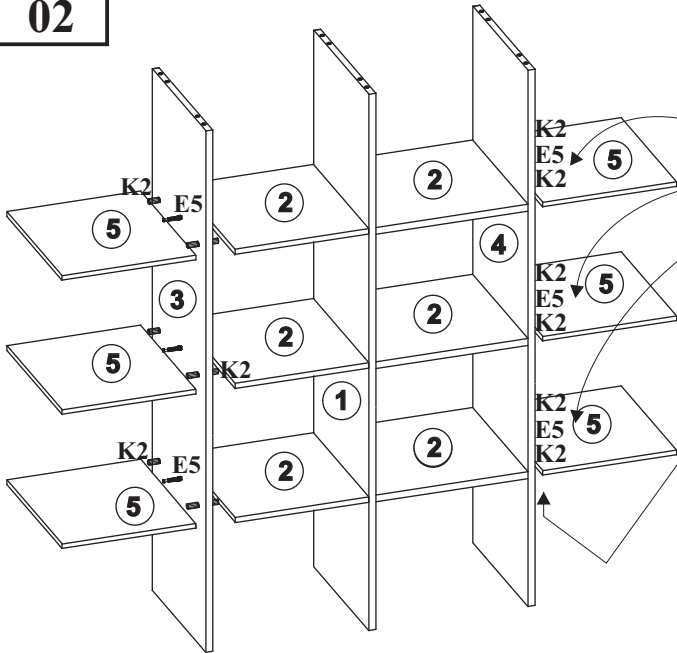

02



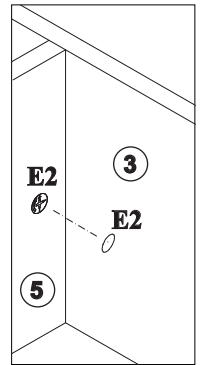
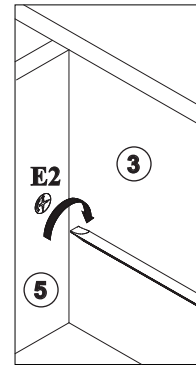
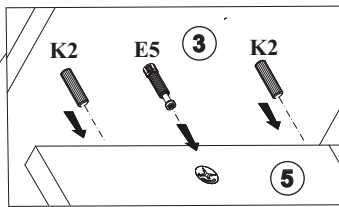

	15x12,5		
E2	x12	E3	x12

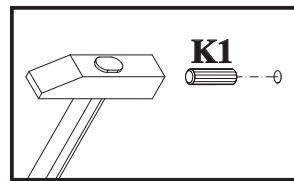
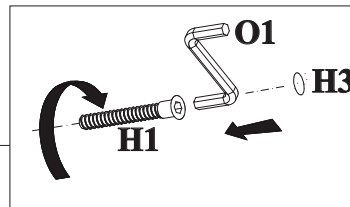
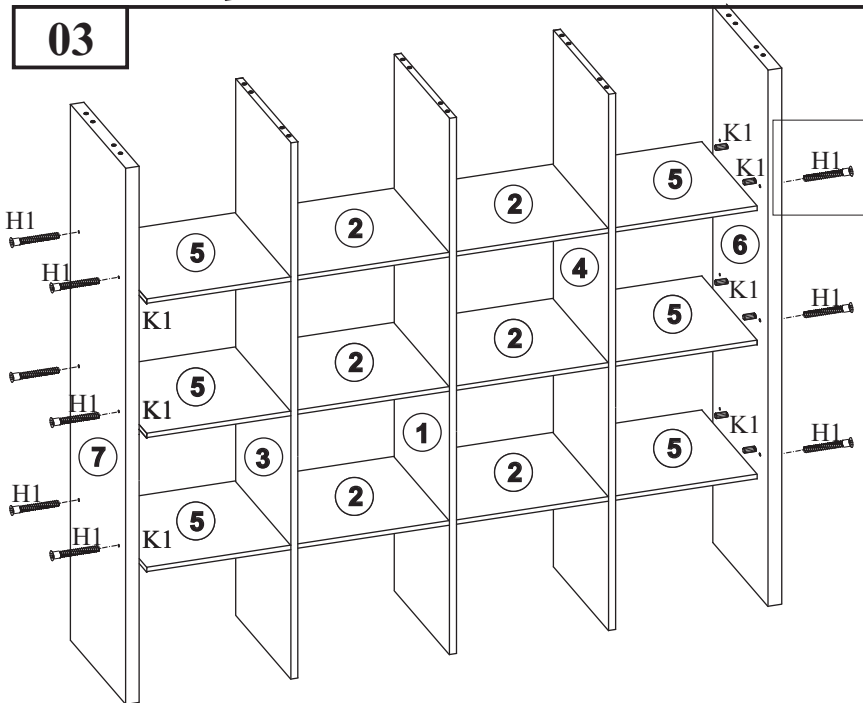

03



	8x35	
K1	x12	

	7x50	
H1	x12	

		
H3	x12	

04

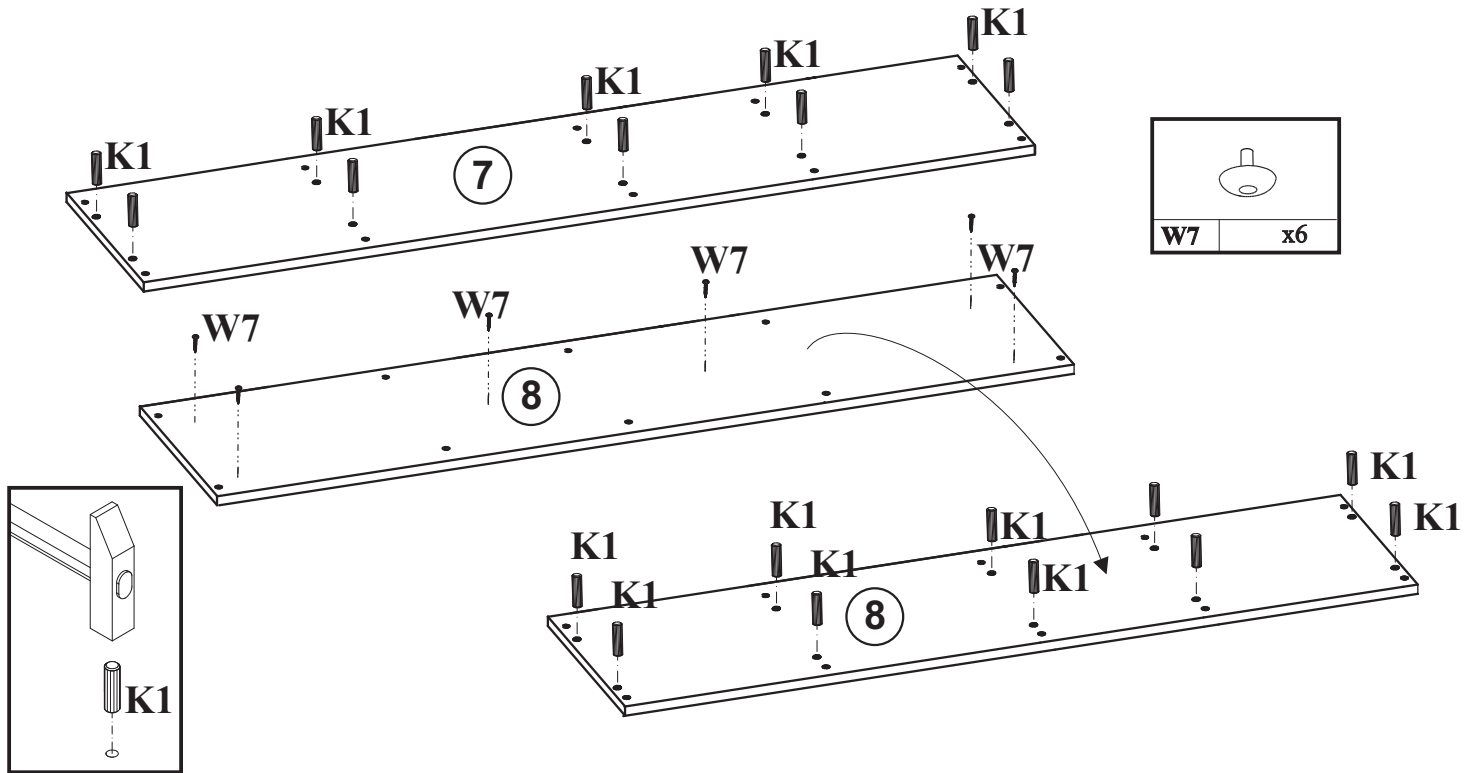

05

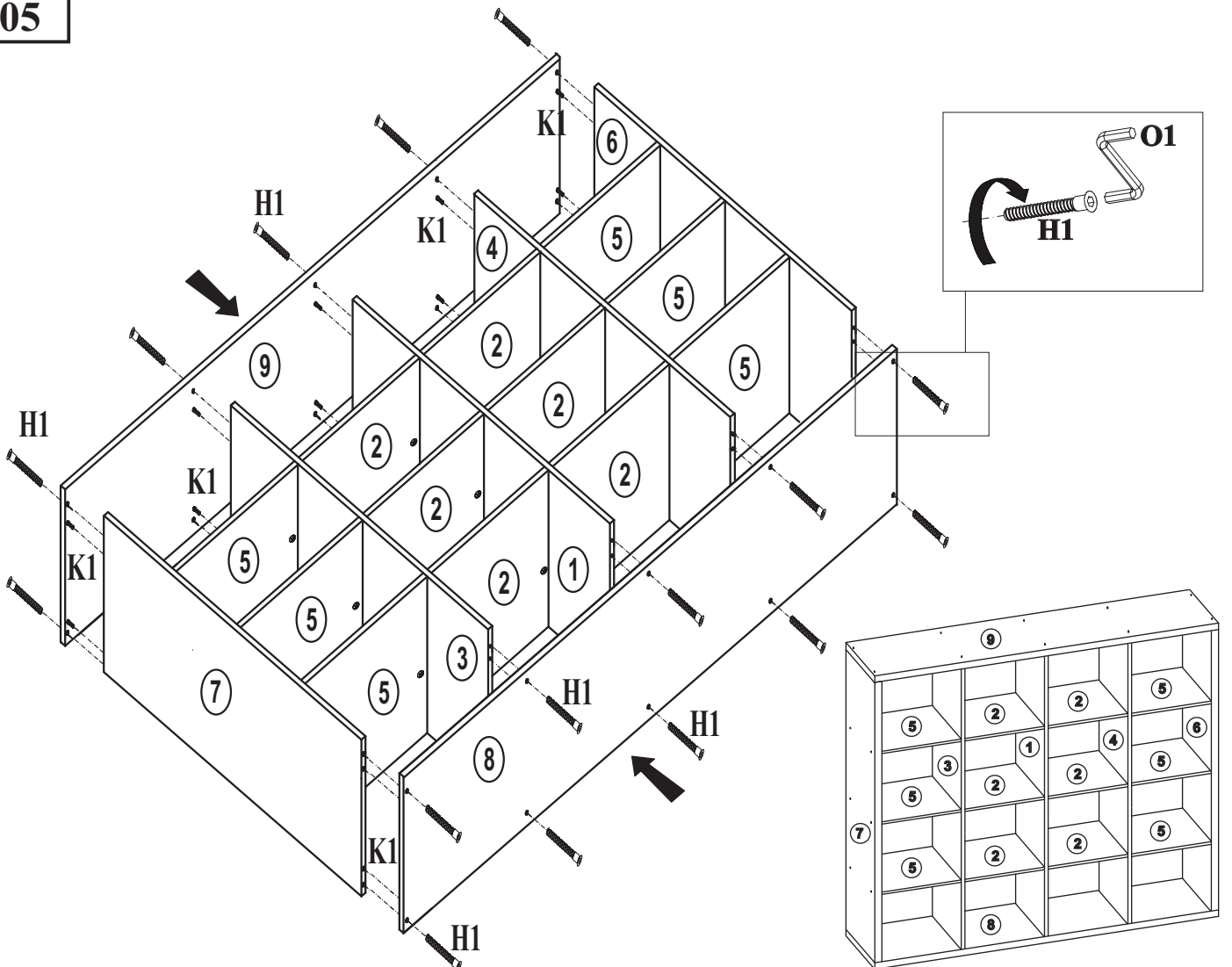

06

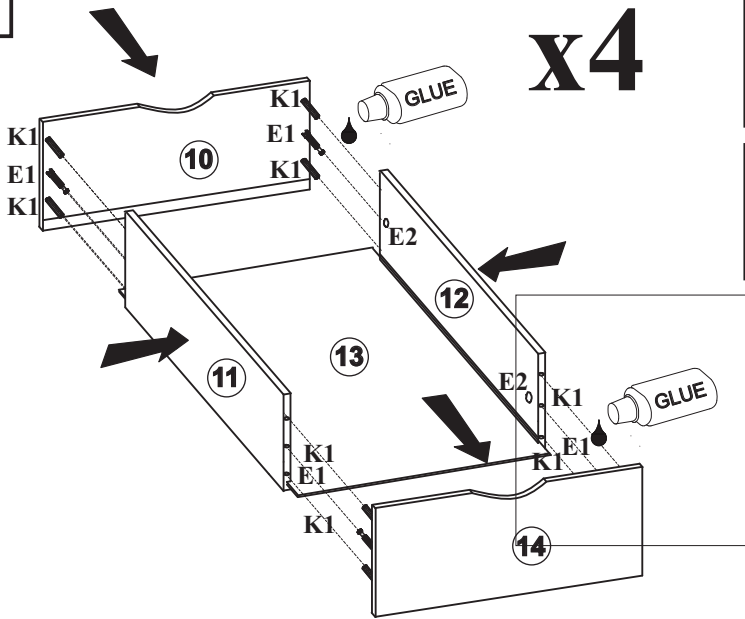

	E1 x16		E2 x16		E3 x16
		15x12,5			

	L1 x1
--	-------

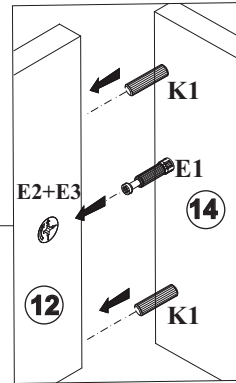

07

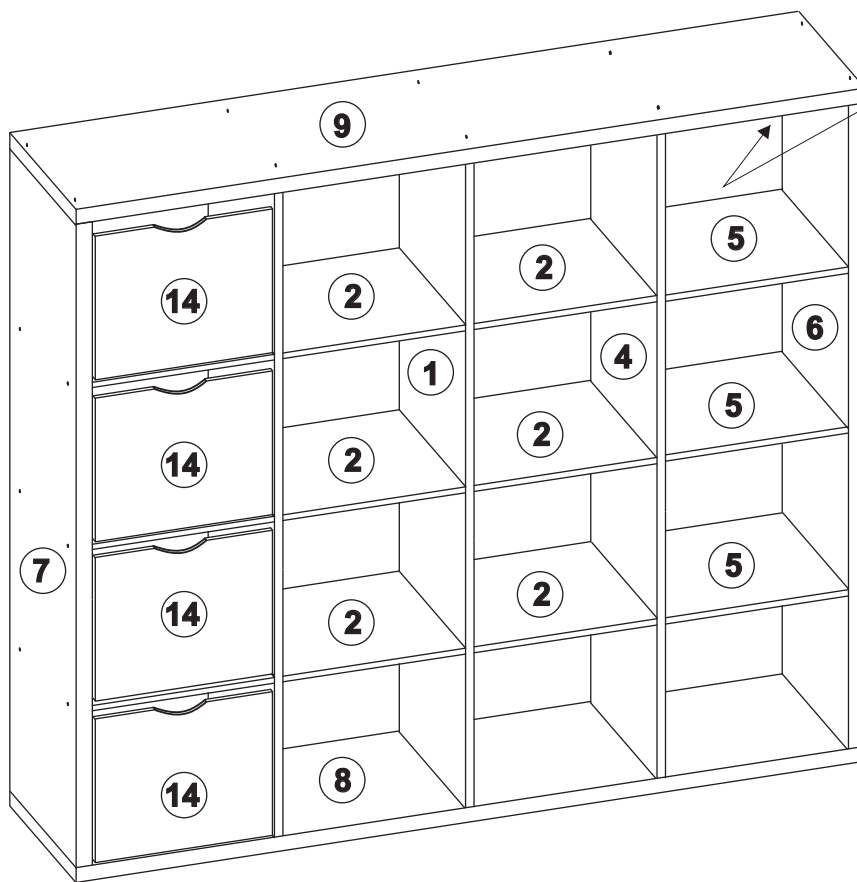

	W6 x1
--	-------

	3x16 W4 x2
	W5 x1

