

90 min

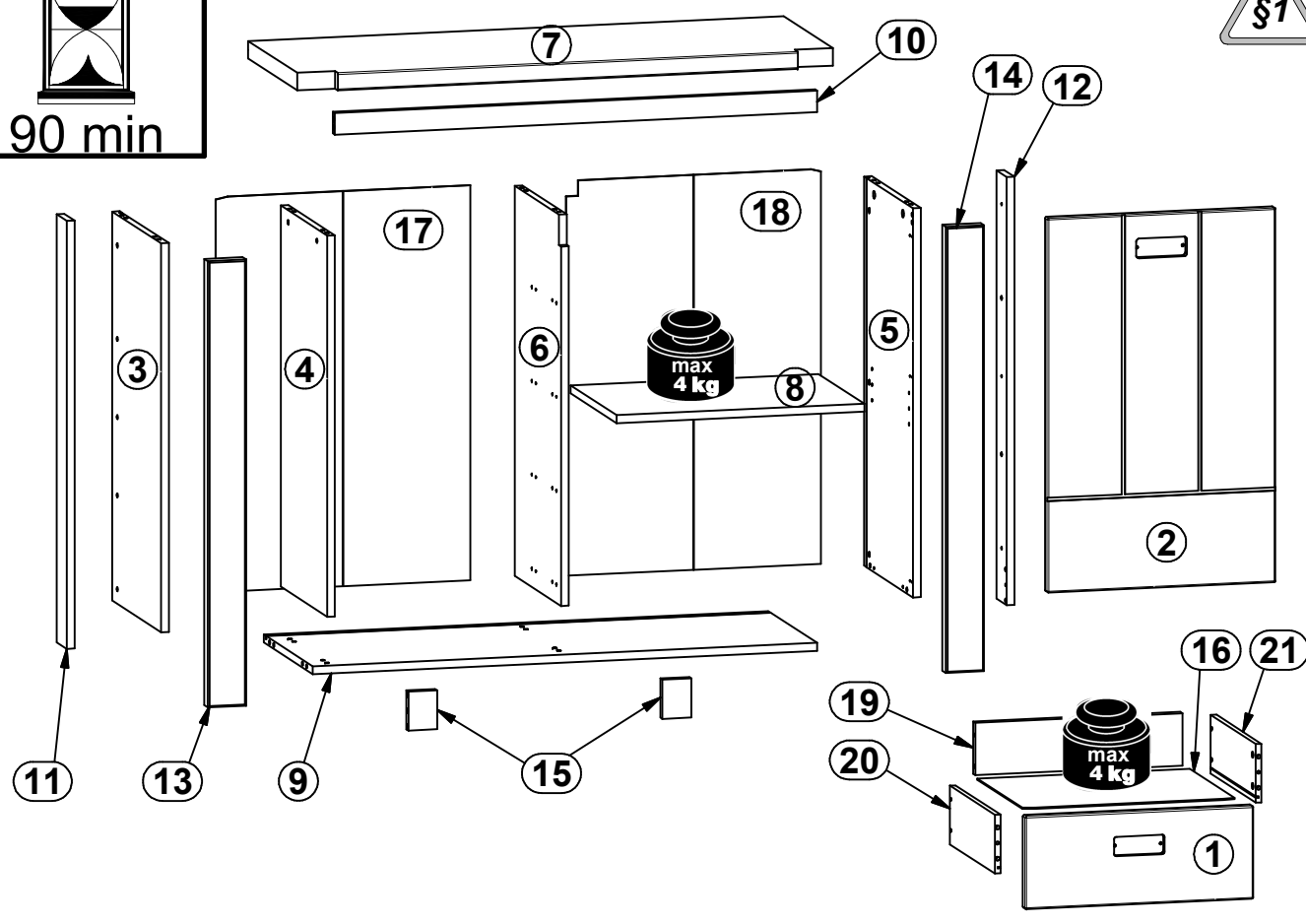

A	B	C (mm)		D
1	S391-0002	476	190	2/3
2	S391-0006	766	476	2/3
3	S391-1001	796	382	1/3
4	S391-1003	780	362	1/3
5	S391-1021	796	382	1/3
6	S391-1022	798	362	1/3
7	S391-2004	1117	405	1/3
8	S391-3003	517	357	2/3
9	S391-3004	1052	382	1/3
10	S391-4004	1006	44	1/3
11	S391-5001	876	80	3/3
12	S391-5002	876	80	3/3
13	S391-5003	913	80	3/3
14	S391-5004	913	80	3/3
15	S391-5005	80	60	3/3
16	S391-9002	443	355	2/3
17	S391-9303	808	531	1/3
18	S391-9305	808	531	1/3
19	ZQ2-1543	432	107	2/3
20	ZQ3-507	350	120	2/3
21	ZQ3-508	350	120	2/3

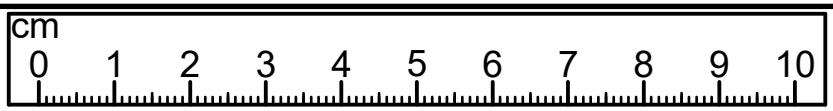
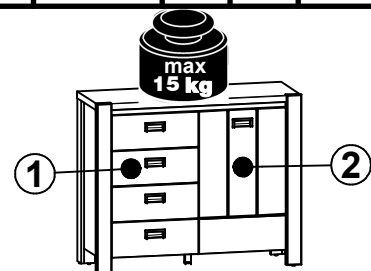

2x a132	1x a133	2x b43	5x c468 96 mm	4x d1 Ø5x17 mm	6x d37	2x e1 Ø7x50 mm	5x e2 Ø6.3x13 mm	32x e3 Ø6x13 mm	6x e22 Ø7x28 mm	28x f1 Ø8x30 mm	8x f9 Ø6x30 mm	4x f13 Ø8x20 mm
16x f25 Ø6.5x40 mm	1x f35 Ø10x50 mm	6x k1	1x k38\3 42.5x42.5\4 mm	1x k38\10 30x30\70 mm	14x l2	1x n14\2 80x21x15\1.5	4x n108 20x13x3.5\1	1x p17 Ø5x60 mm	46x p38 Ø3.5x16 mm	4x p51 Ø3.5x15 mm	12x p55 Ø2.9x16 mm	10x p59 Ø4x12 mm
12x r1 Ø15x12 mm #16	16x r15 Ø12x10.5 mm #12	28x r42 20/11	4x w167L 350mm	4x w167P 350mm	2x s1	4x s2 Ø16	1x z1 4 mm					

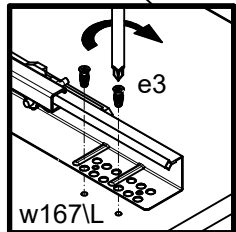
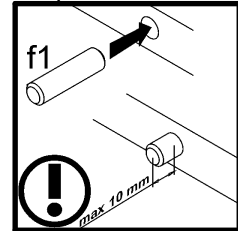
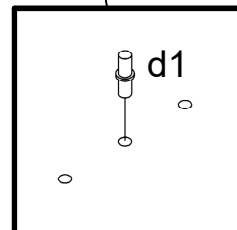
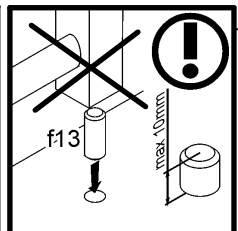
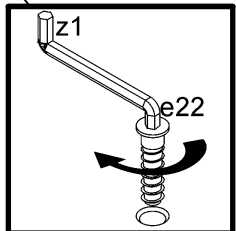
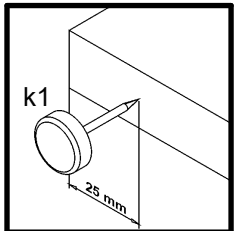
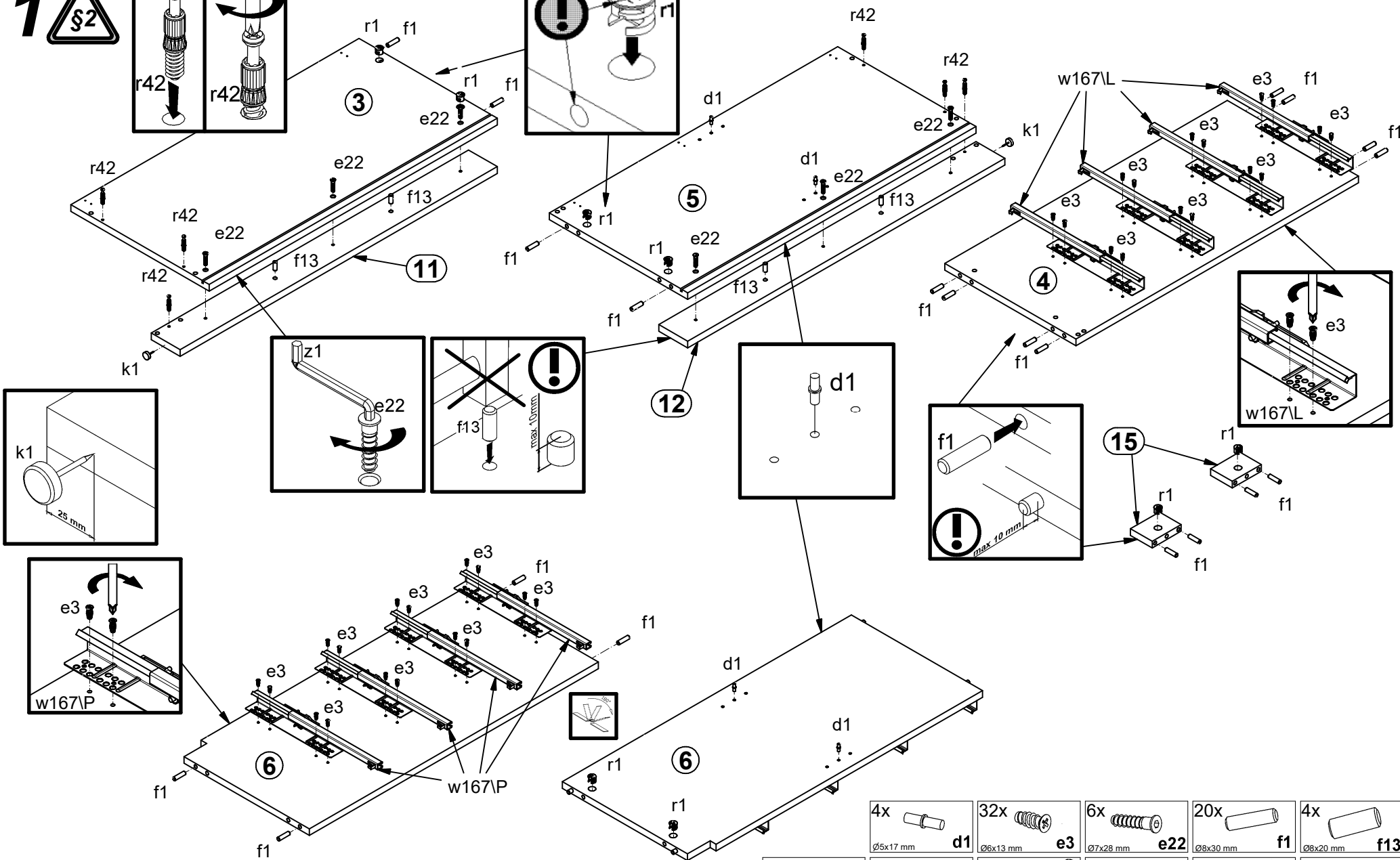
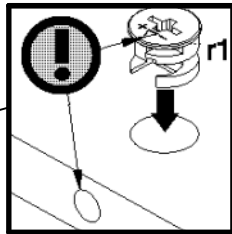
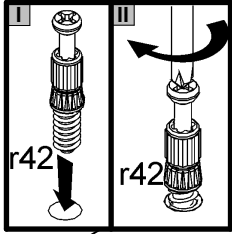

4x Ø5x17 mm d1	32x Ø6x13 mm e3	6x Ø7x28 mm e22	20x Ø8x30 mm f1	4x Ø8x20 mm f13
2x k1	8x Ø15x12 mm #16 r1	6x 20/11 r42	4x 350mm w167L	4x 350mm w167P
				1x 4 mm z1

2

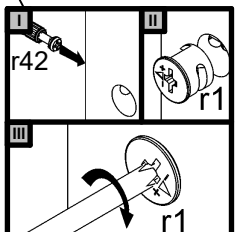
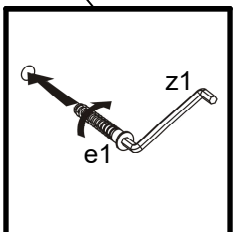
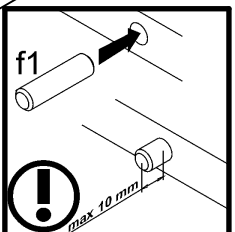
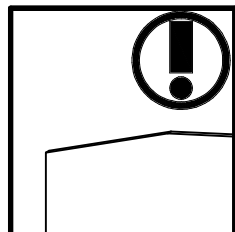
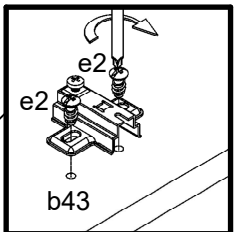
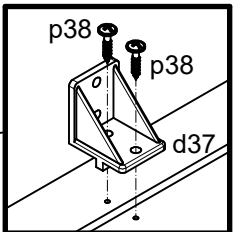
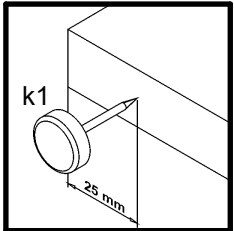
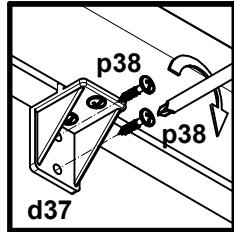
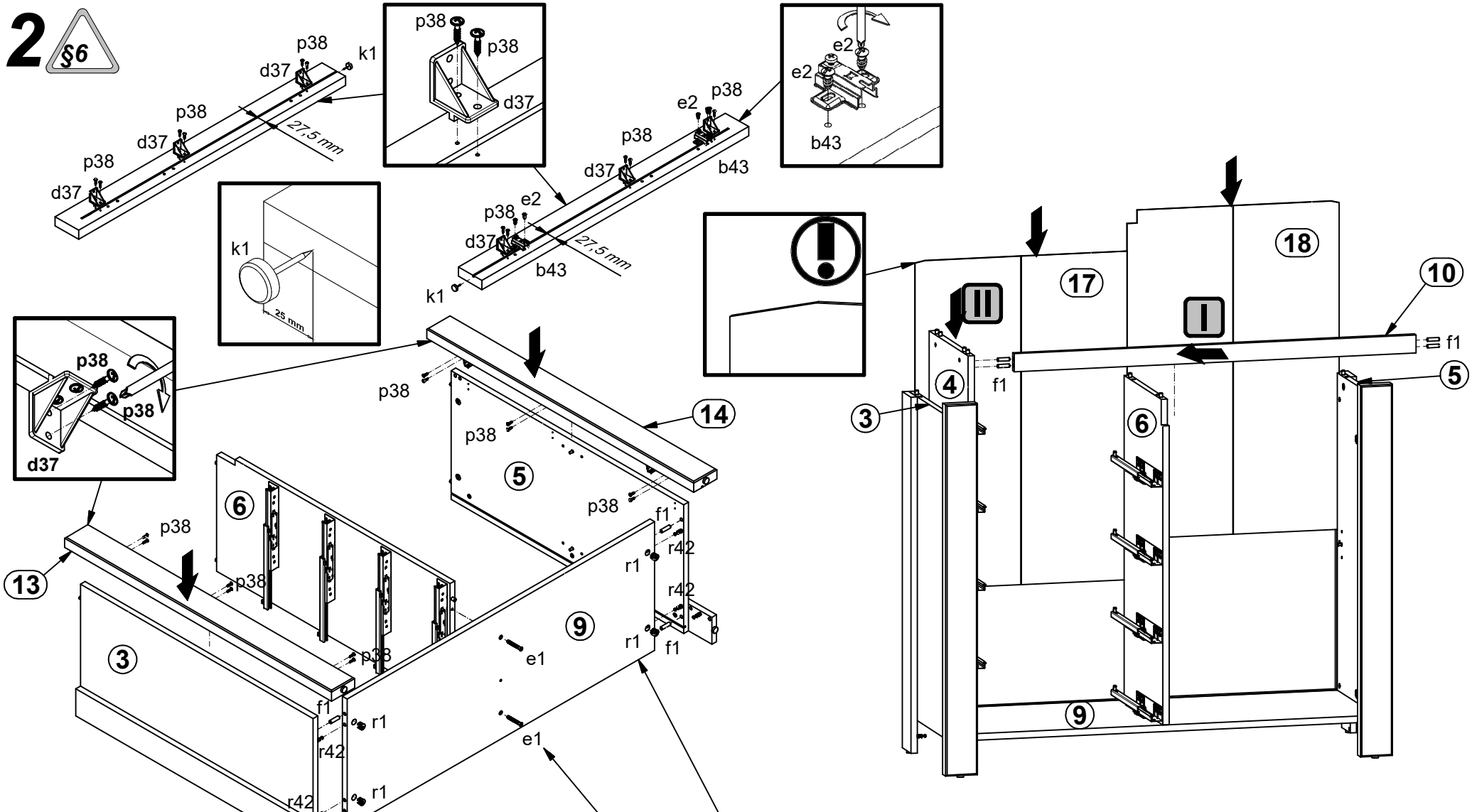

8x Ø8x30 mm f1	2x b43	6x d37	2x Ø7x50 mm e1	4x Ø6.3x13 mm e2
2x k1	24x Ø3.5x12 mm #16 p38	4x Ø15x12 mm #16 r1	1x 4 mm z1	

3 §6

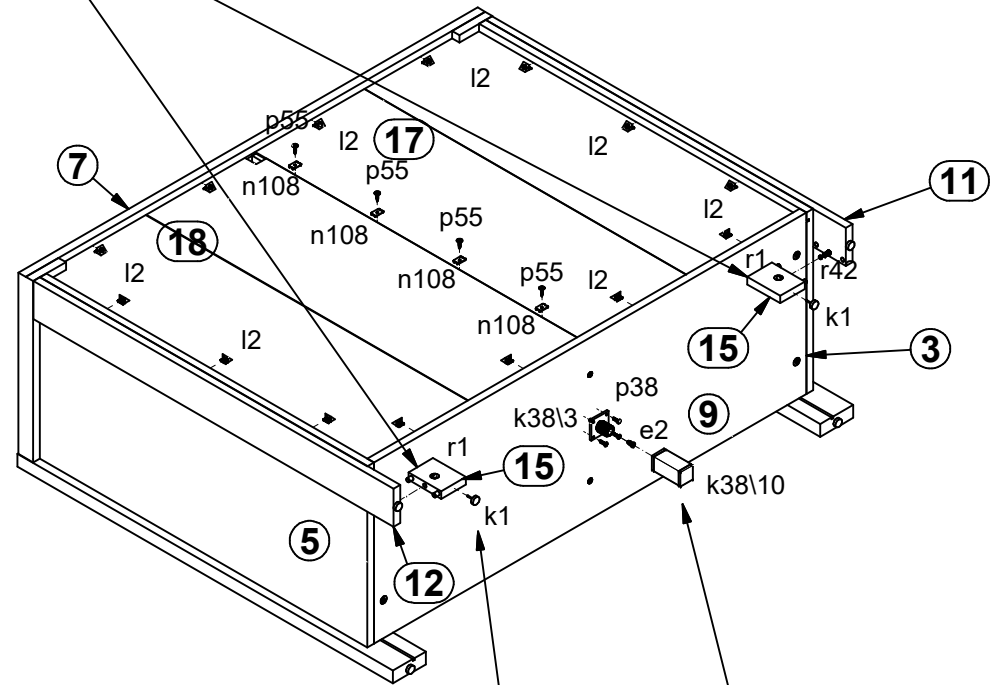
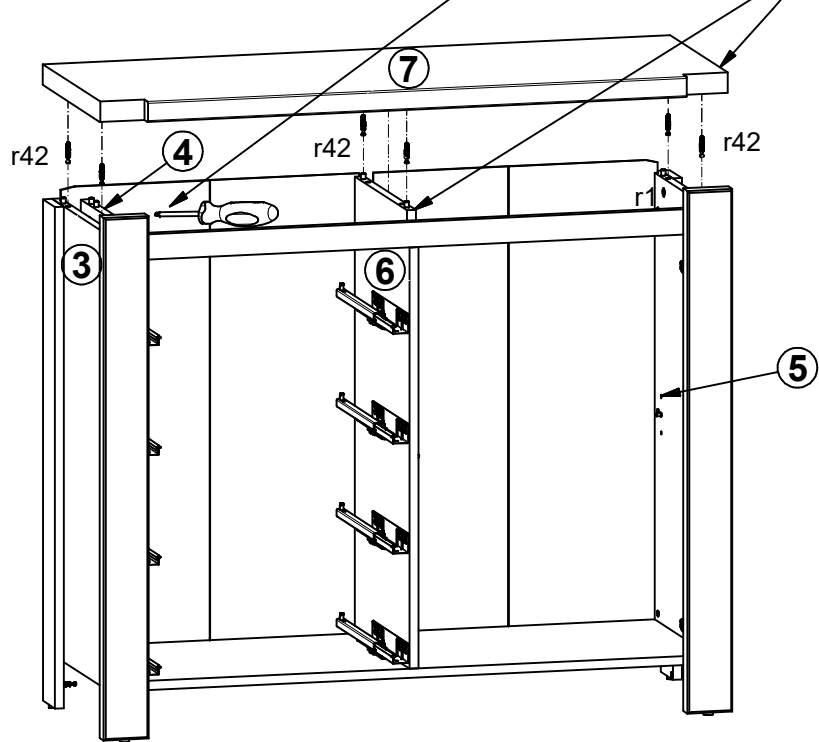
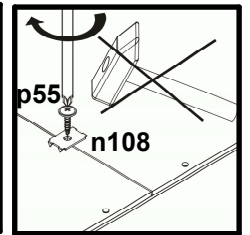
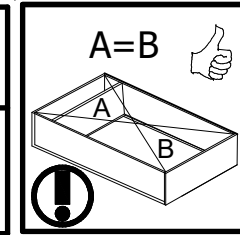
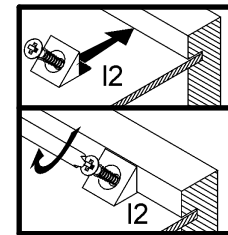
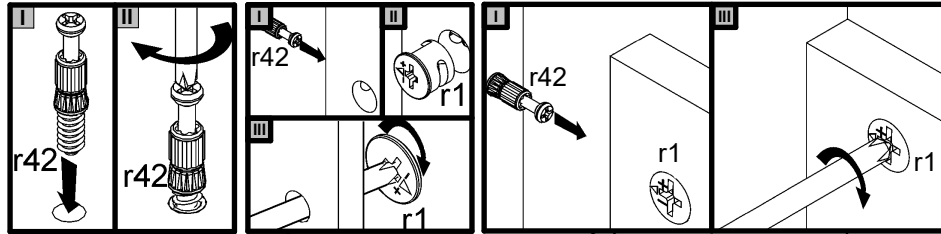



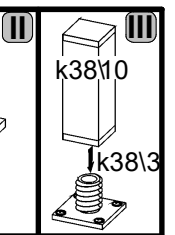
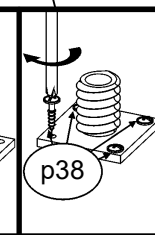
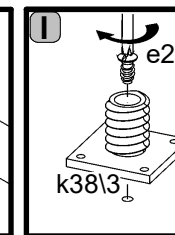
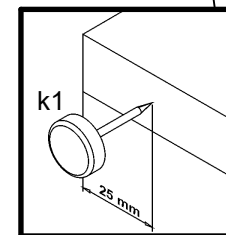

- | | | | |
|------------------------|-------------------------|-------------------------------|----------------------------|
| 1x
Ø6,3x13 mm
e2 | 2x
k1 | 1x
42,5x42,5x4 mm
k3813 | 1x
30x30/70 mm
k3810 |
| 14x
l2 | 4x
20x13x3,5
n108 | 4x
Ø3,5x16 mm
p38 | 4x
Ø2,9x16 mm
p55 |
| | | 6x
20/11
r42 | |

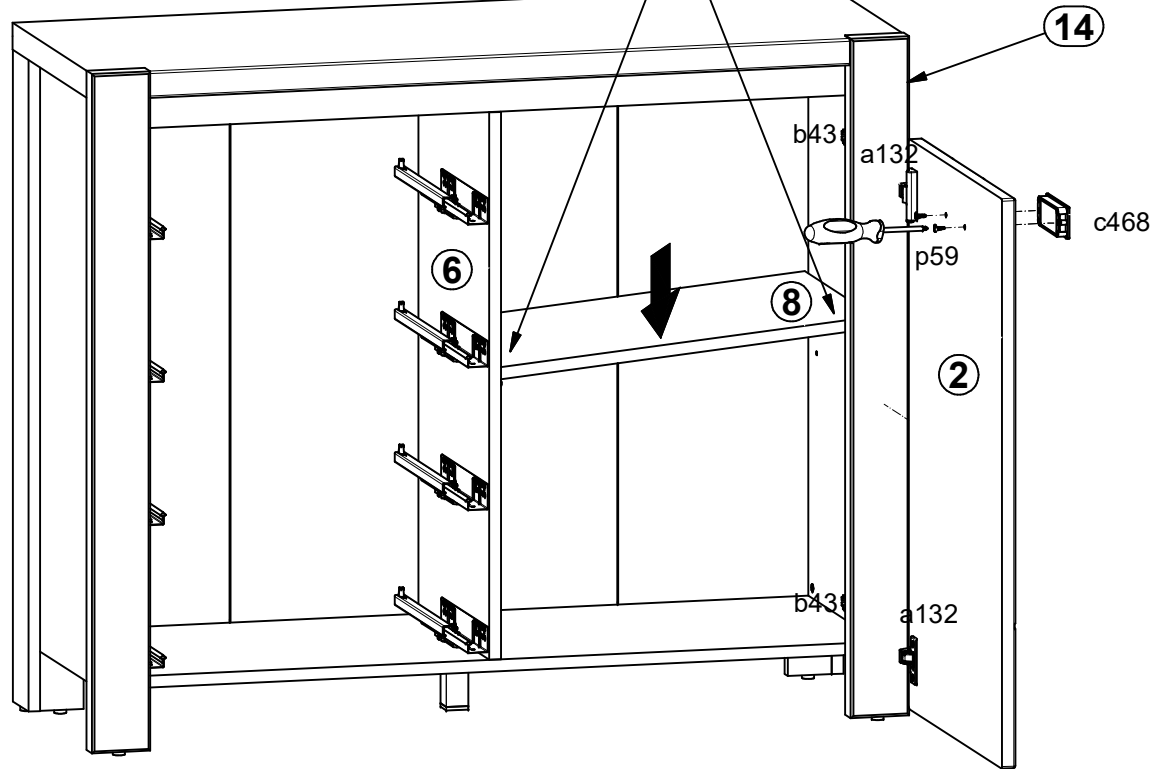
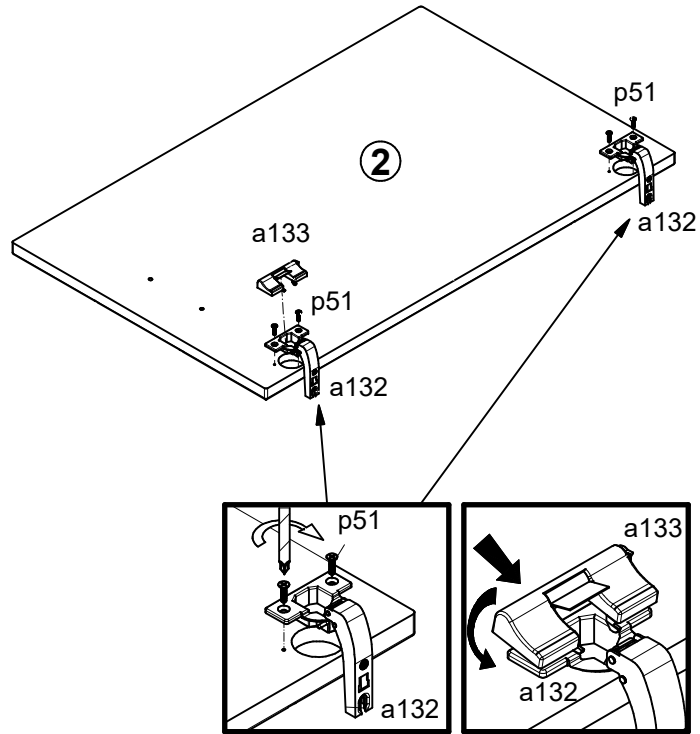
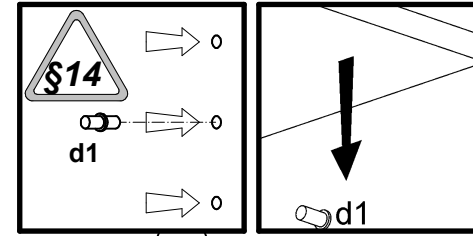

4 §6



- 2x  a132
- 1x  a133
- 1x  c468
- 4x  p51
- 2x  p59

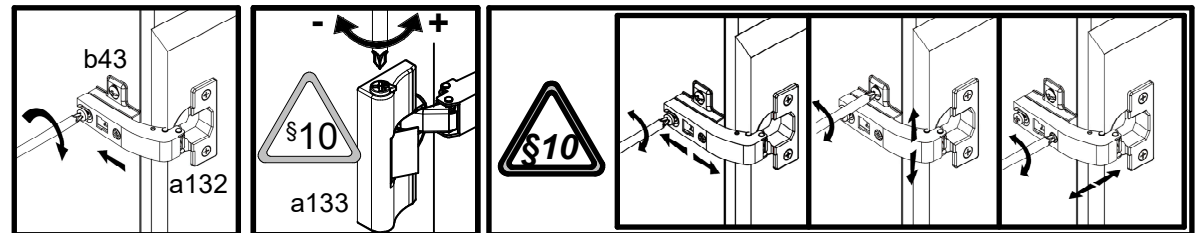

5 

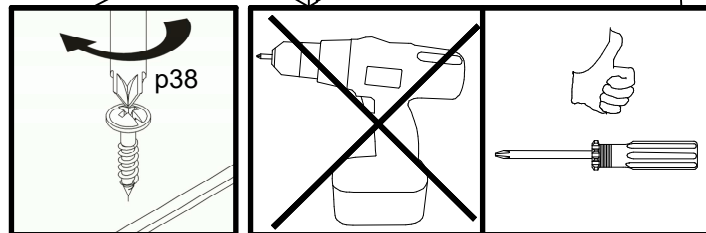
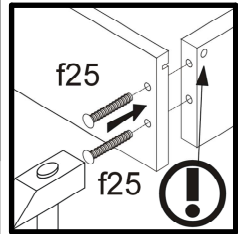
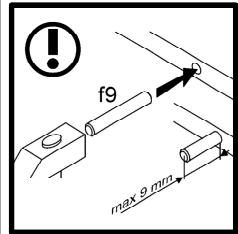
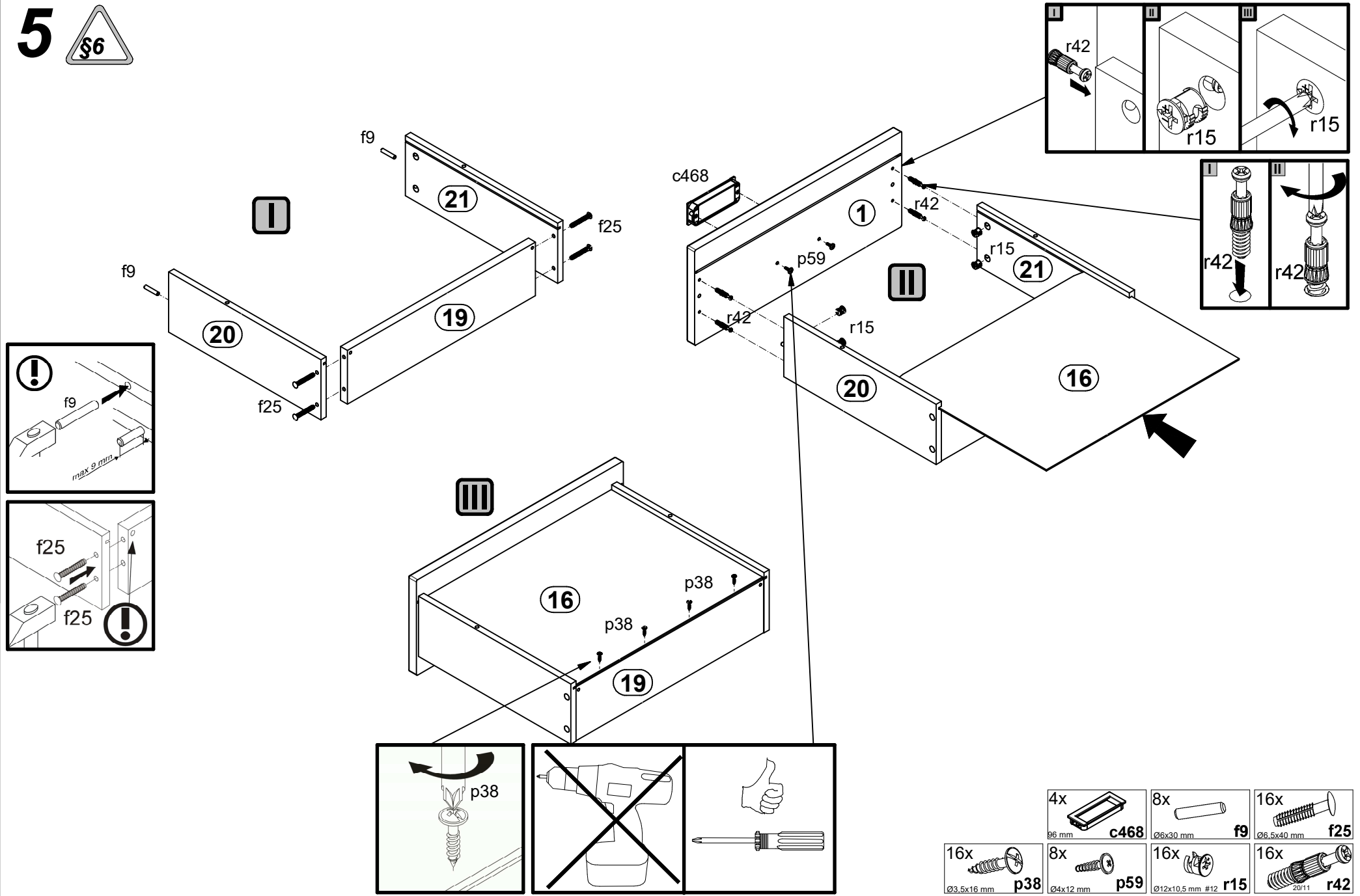

4x 96 mm c468	8x Ø6x30 mm f9	16x Ø6,5x40 mm f25
16x Ø3,5x16 mm p38	8x Ø4x12 mm p59	16x Ø12x10,5 mm #12 r15
		16x 20/11 r42

6

