

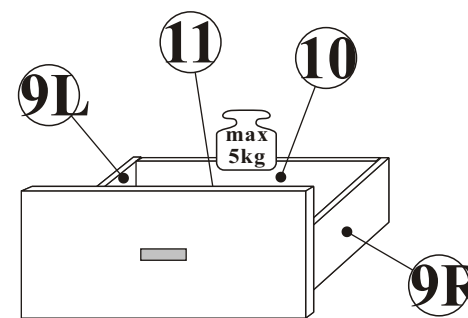

90 min

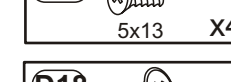

NO	Dim.		Col.-No	Qty
1	560	376	1	1
2	724	284	1	1
3	724	284	1	1
4	382	284	1	1
5	348	250	1	1
6	735	359	1	1
7	382	308	1	1
8	171	376	1	1
9L	250	100	1	1
9R	250	100	1	1
10	315	86	1	1
11	325	255	1	1

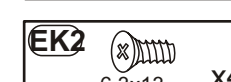
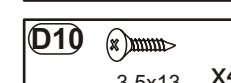
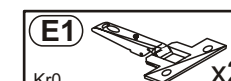
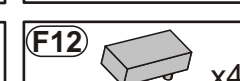
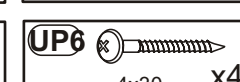
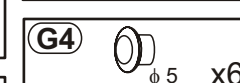
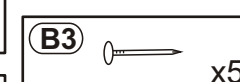
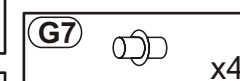
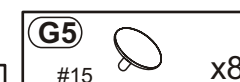
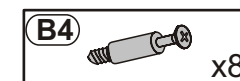
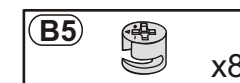
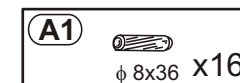
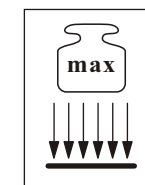
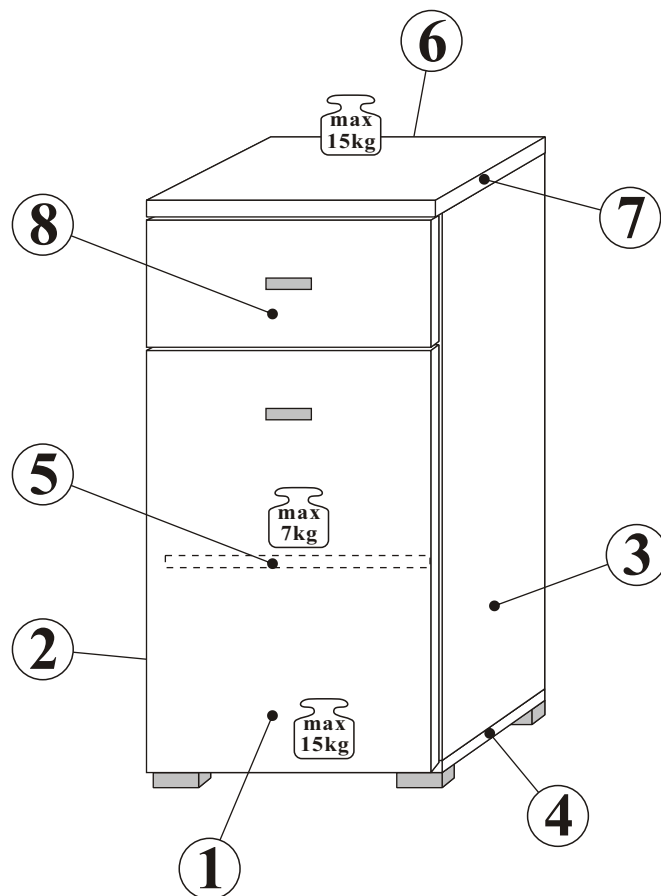
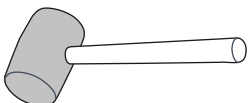
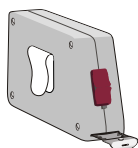
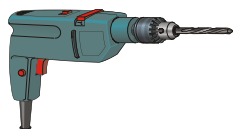
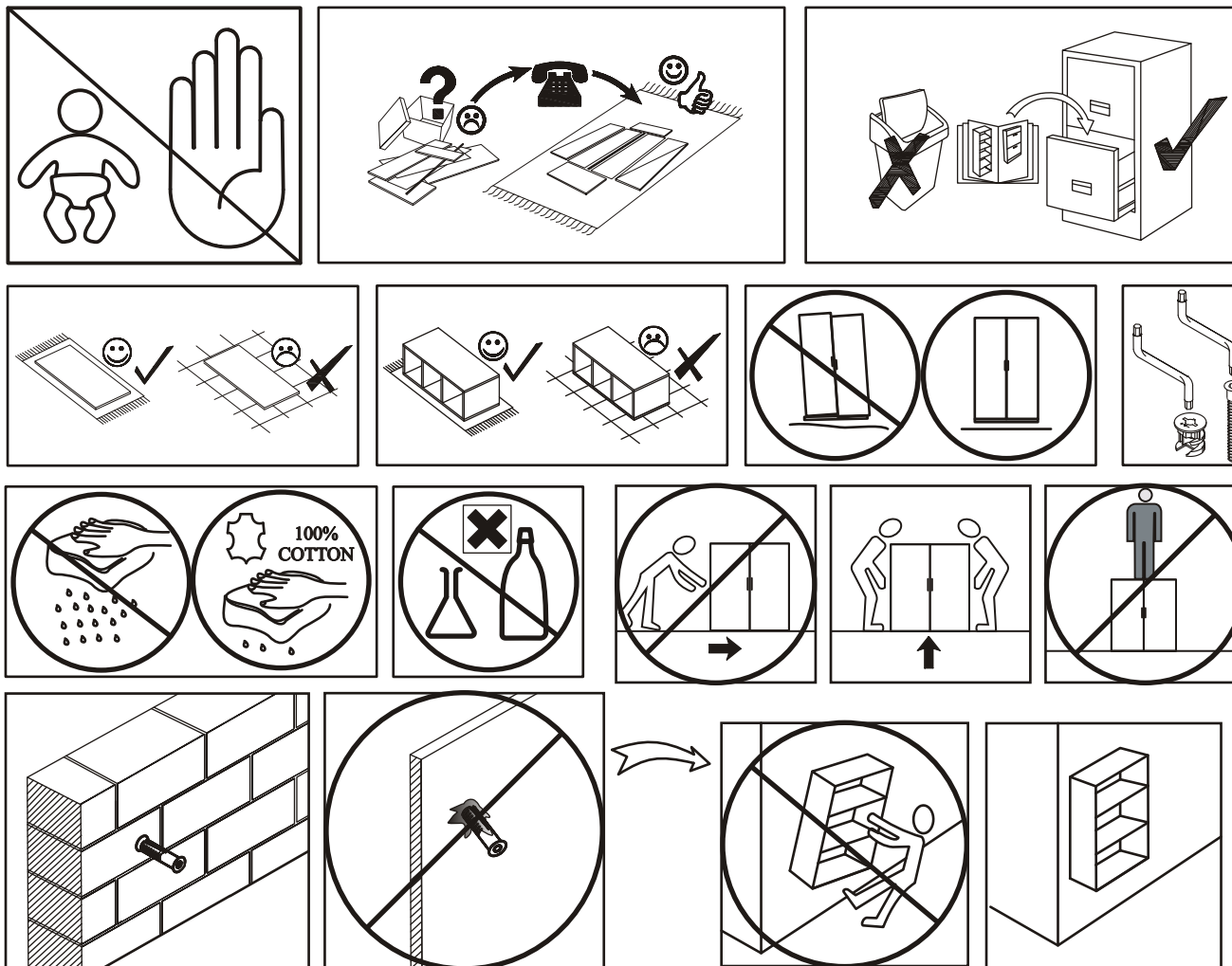

1

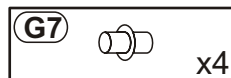
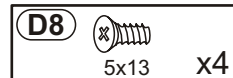
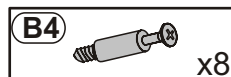
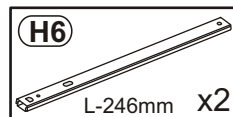
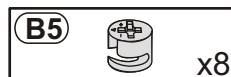
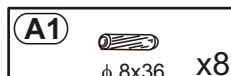
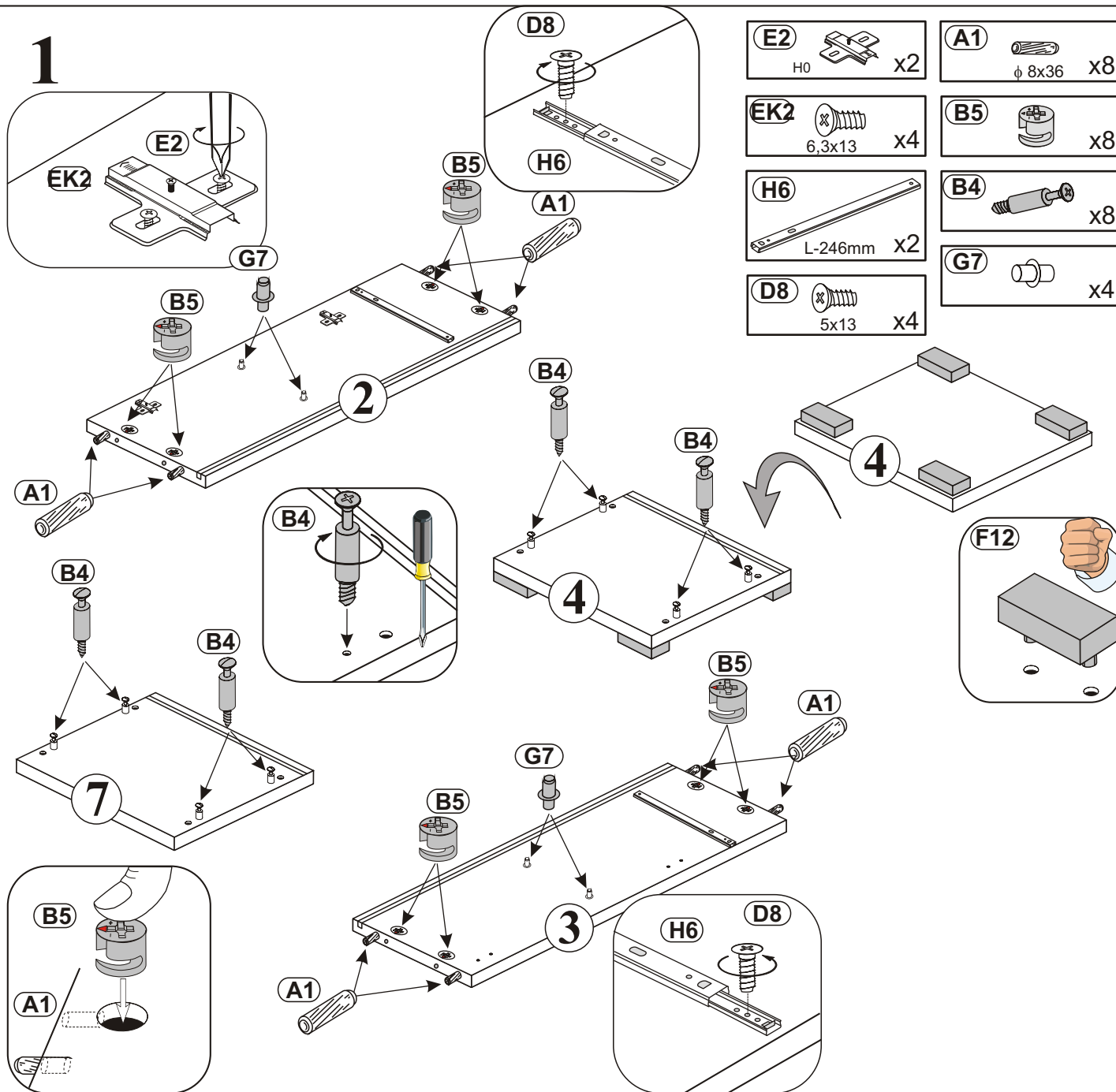

2

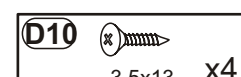
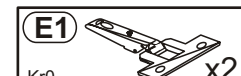
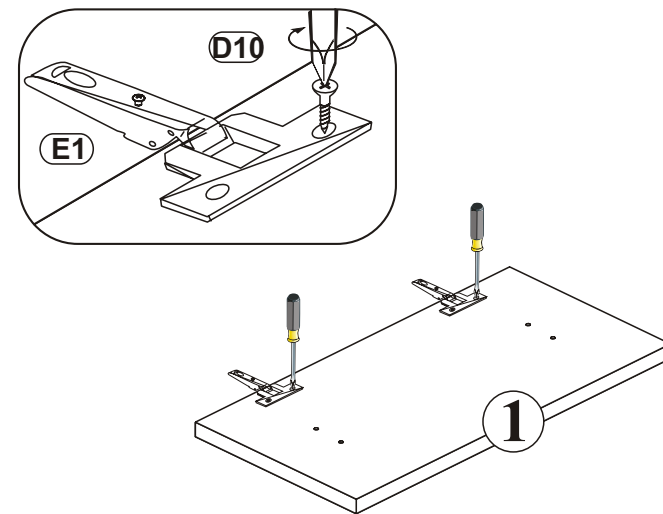

3

- A1** ϕ 8x36 x8
- W32** x1
- UP6** 4x30 x2
- G1** x1
- B3** x5
- G3**

4

5

6



a=b

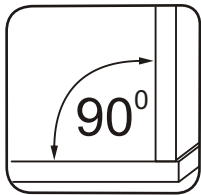
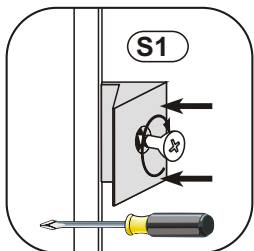
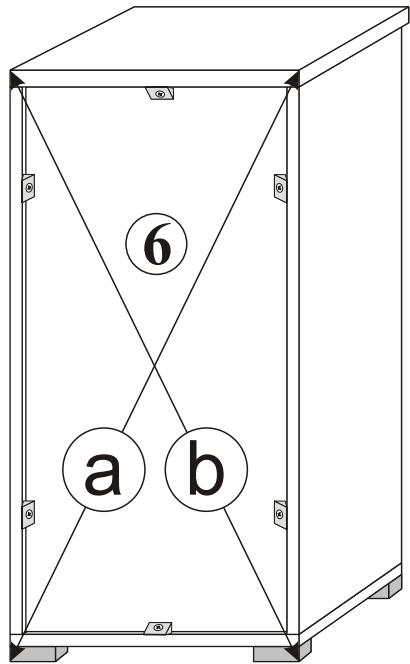

7

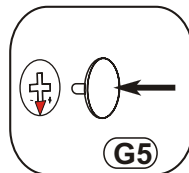
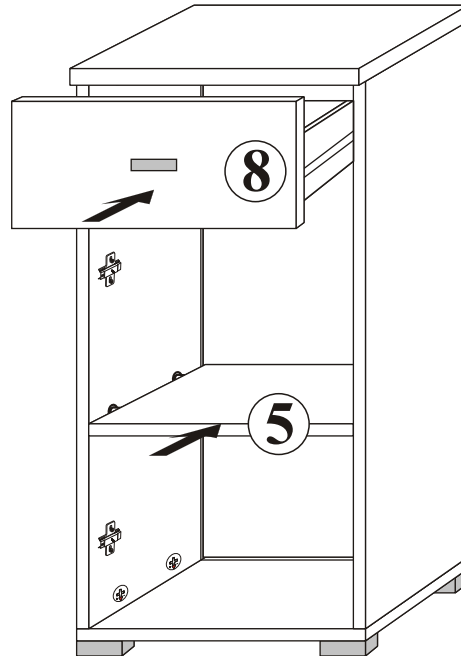
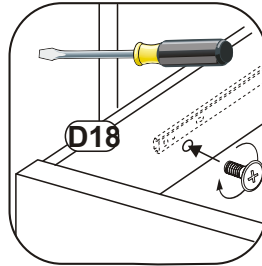

8

